

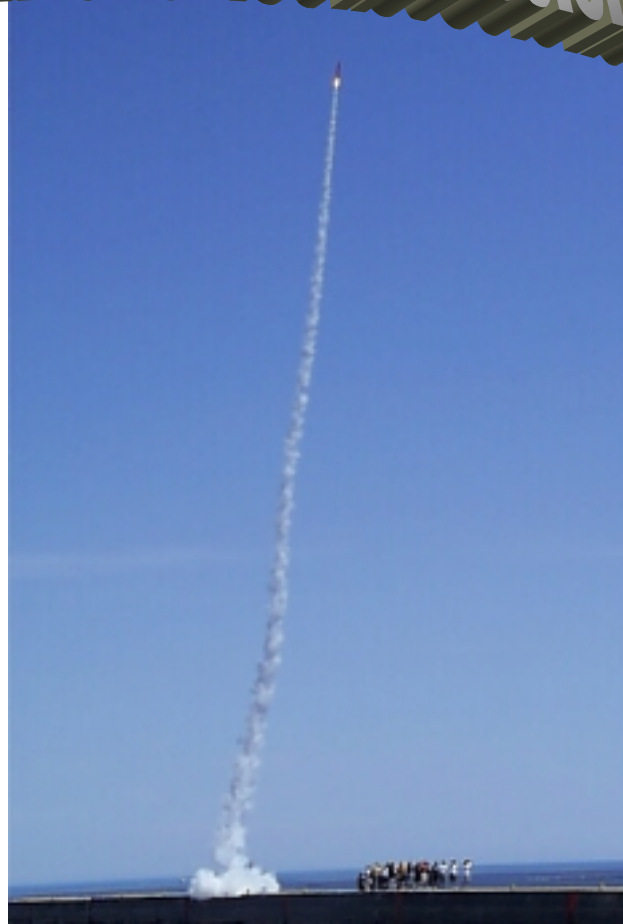

# Rocketry Basics

## This is Rocket Science



**This pamphlet was developed using information from the Education Working Group—NASA Johnson Space Center**

*<http://quest.arc.nasa.gov/space/teachers/rockets/>*

---

## Acknowledgments

This publication was developed for the National Aeronautics and Space Administration with the assistance of hundreds of teachers in the Texas Region IV area and educators of the Aerospace Education Services Program, Oklahoma State University.

Writers:

**Deborah A. Shearer**  
**Gregory L. Vogt, Ed.D.**  
Teaching From Space Program  
NASA Johnson Space Center  
Houston, TX

Editor:

**Carla B. Rosenberg**  
Teaching From Space Program  
NASA Headquarters  
Washington, DC

Special Thanks to:

**Timothy J. Wickenheiser**  
Chief, Advanced Mission Analysis Branch  
NASA Lewis Research Center

**Gordon W. Eskridge**  
Aerospace Education Specialist  
Oklahoma State University

Dale M. Olive  
Teacher, Hawaii



# Brief History of Rockets

**T**oday's rockets are remarkable collections of human ingenuity that have their roots in the science and technology of the past. They are natural outgrowths of literally thousands of years of experimentation and research on rockets and rocket propulsion.

One of the first devices to successfully employ the principles essential to rocket flight was a wooden bird. The writings of Aulus Gellius, a Roman, tell a story of a Greek named Archytas who lived in the city of Tarentum, now a part of southern Italy. Somewhere around the year 400 B.C., Archytas mystified and amused the citizens of Tarentum by flying a pigeon made of wood. Escaping steam propelled the bird suspended on wires. The pigeon used the action-reaction principle, which was not to be stated as a scientific law until the 17th century.

About three hundred years after the pigeon, another Greek, Hero of Alexandria, invented a similar rocket-like device called an *aeolipile*. It, too, used steam as a propulsive gas. Hero mounted a sphere on top of a water kettle. A fire below the kettle turned the water into steam, and the gas traveled through pipes to the sphere. Two L-shaped tubes on opposite sides of the sphere allowed the gas to escape, and in doing so gave a thrust to the sphere that caused it to rotate.

Just when the first true rockets appeared is unclear. Stories of early rocket-like devices appear sporadically through the historical records of various cultures. Perhaps the first true rockets were accidents. In the first century A.D., the Chinese reportedly had a simple form of gunpowder made from saltpeter, sulfur, and charcoal dust. They used the gunpowder mostly for fireworks in religious and other festive celebrations. To create explosions during religious festivals, they filled bamboo tubes with the mixture and tossed them into fires. Perhaps some of those tubes failed to explode and instead skittered out of the fires, propelled by the gases and sparks produced from the burning gunpowder.

The Chinese began experimenting with the gunpowder-filled tubes. At some point, they attached bamboo tubes to arrows and launched them with bows. Soon they discovered that these gunpowder tubes could launch themselves just by the power produced from the escaping gas. The true rocket was

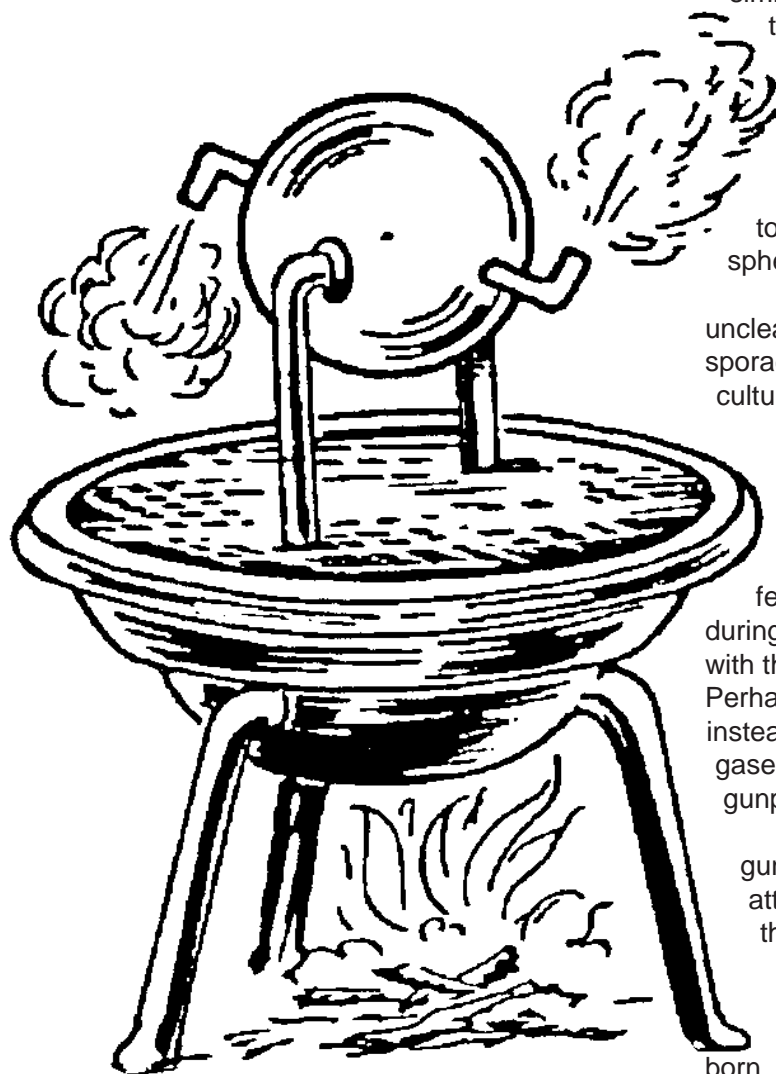

Hero Engine

born.



The date reporting the first use of true rockets was in 1232. At this time, the Chinese and the Mongols were at war with each other. During the battle of Kai-Keng, the Chinese repelled the Mongol invaders by a barrage of “arrows of flying fire.” These fire-arrows were a simple form of a solid-propellant rocket. A tube, capped at one end, contained gunpowder. The other end was left open and the tube was attached to a long stick. When the powder ignited, the rapid burning of the powder produced fire, smoke, and gas that escaped out the open end and produced a thrust. The stick acted as

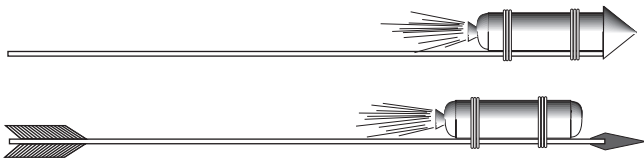

Chinese Fire-Arrows

a simple guidance system that kept the rocket headed in one general direction as it flew through the air. How effective these arrows of flying fire were as weapons of destruction is not clear, but their psychological effects on the Mongols must have been formidable.

Following the battle of Kai-Keng, the Mongols produced rockets of their own and may have been responsible for the spread of rockets to Europe. Many records describe rocket experiments through out the 13th to the 15th centuries. In England, a monk named Roger Bacon worked on improved forms of gunpowder that greatly increased the range of rockets. In France, Jean Froissart achieved more accurate flights by launching rockets through tubes. Froissart’s idea was the forerunner of the modern bazooka. Joanes de Fontana of Italy designed a surface-running rocket-powered torpedo for setting enemy ships on fire.



Chinese soldier launches a fire-arrow.

By the 16th century rockets fell into a time of disuse as weapons of war, though they were still used for fireworks displays, and a German fireworks maker, Johann Schmidlap, invented the “step rocket,” a multi-staged vehicle for lifting fireworks to higher altitudes. A large sky rocket (first stage) carried a smaller sky rocket (second stage). When the large rocket burned out, the smaller one continued to a higher altitude before showering the sky with glowing cinders. Schmidlap’s idea is basic to all rockets today that go into outer space.

Nearly all uses of rockets up to this time were for warfare or fireworks, but an interesting old Chinese legend reports the use of rockets as a means of transportation. With the help of many

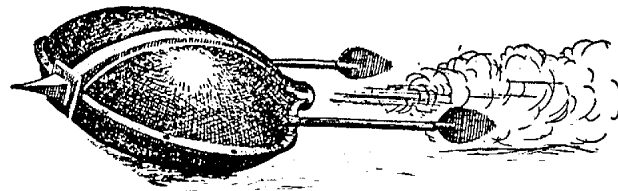

Surface-Running Torpedo

assistants, a lesser-known Chinese official named Wan-Hu assembled a rocket-powered flying chair. He had two large kites attached to the chair, and fixed to the kites were forty-seven fire-arrow rockets.

On the day of the flight, Wan-Hu sat himself on the chair and gave the command to light the rockets. Forty-seven rocket assistants, each armed with torches, rushed forward to light the fuses. A tremendous roar filled the air, accompanied by billowing clouds of smoke. When the smoke cleared, Wan-Hu and his flying chair were gone. No one knows for sure what happened to Wan-Hu, but if the event really did take place, Wan-Hu and his chair probably did not survive the explosion. Fire-arrows were as apt to explode as to fly.

## Rocketry Becomes a Science

During the latter part of the 17th century, the great English scientist Sir Isaac Newton (1642-1727) laid the scientific foundations for modern rocketry. Newton organized his understanding of physical motion into three scientific laws. The laws explain how rockets work and why they are able to work in the vacuum of outer space. (See Rocket Principles for more information on Newton’s Three Laws of Motion beginning on page 13.)



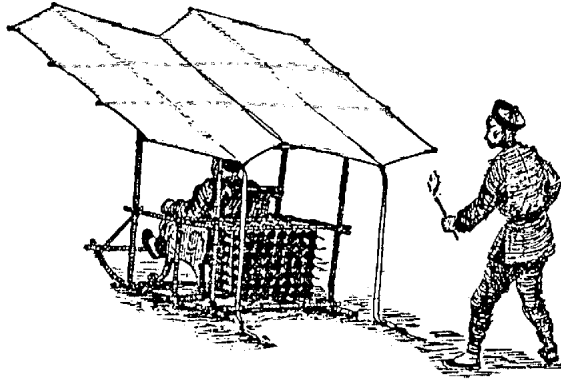

Legendary Chinese official Wan Hu braces himself for "liftoff."

Newton's laws soon began to have a practical impact on the design of rockets. About 1720, a Dutch professor, Willem Gravesande, built model cars propelled by jets of steam. Rocket experimenters in Germany and Russia began working with rockets with a mass of more than 45 kilograms. Some of these rockets were so powerful that their escaping exhaust flames bored deep holes in the ground even before liftoff.

During the end of the 18th century and early into the 19th, rockets experienced a brief revival as a weapon of war. The success of Indian rocket barrages against the British in 1792 and again in 1799 caught the interest of an artillery expert, Colonel William Congreve. Congreve set out to design rockets for use by the British military.

The Congreve rockets were highly successful in battle. Used by British ships to pound Fort McHenry in the War of 1812, they inspired Francis Scott Key to write "the rockets' red glare," in his poem that later became *The Star-Spangled Banner*.

Even with Congreve's work, the accuracy of rockets still had not improved much from the early days. The devastating nature of war rockets was not their accuracy or power, but their numbers. During a typical siege, thousands of them might be fired at the enemy. All over the world, rocket researchers experimented with ways to improve accuracy. An Englishman, William Hale, developed a technique called spin stabilization. In this method, the escaping exhaust gases struck small vanes at the bottom of the rocket, causing it to spin much as a bullet does in flight. Many rockets still use variations of this principle today.

Rocket use continued to be successful in battles all over the European continent. However, in a war with Prussia, the

Austrian rocket brigades met their match against newly designed artillery pieces. Breech-loading cannon with rifled barrels and exploding warheads were far more effective weapons of war than the best rockets. Once again, the military relegated rocketry to peacetime uses.

## Modern Rocketry Begins

In 1898, a Russian schoolteacher, Konstantin Tsiolkovsky (1857-1935), proposed the idea of space exploration by rocket. In a report he published in 1903, Tsiolkovsky suggested the use of liquid propellants for rockets in order to achieve greater range. Tsiolkovsky stated that only the exhaust velocity of escaping gases limited the speed and range of a rocket. For his ideas, careful research, and great vision, Tsiolkovsky has been called the father of modern astronautics.

Early in the 20th century, an American, Robert H. Goddard (1882-1945), conducted practical experiments in rocketry. He had become interested in a way of achieving higher altitudes than were possible for lighter-than-air balloons. He published a pamphlet in 1919 entitled *A Method of Reaching Extreme Altitudes*. Today we call this mathematical analysis the meteorological sounding rocket.

In his pamphlet, Goddard reached several conclusions important to rocketry. From his tests, he stated that a rocket operates with greater

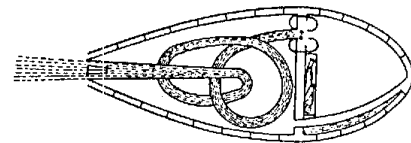
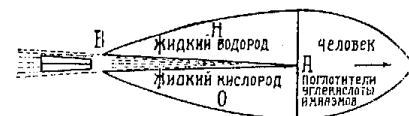

Tsiolkovsky Rocket Designs



efficiency in a vacuum than in air. At the time, most people mistakenly believed that the presence of air was necessary for a rocket to push against. A *New York Times* newspaper editorial of the day mocked Goddard's lack of the "basic physics ladled out daily in our high schools." Goddard also stated that multistage or step rockets were the answer to achieving high altitudes and that the velocity needed to escape Earth's gravity could be achieved in this way.

Goddard's earliest experiments were with solid-propellant rockets. In 1915, he began to try various types of solid fuels and to measure the exhaust velocities of the burning gases.

While working on solid-propellant rockets, Goddard became convinced that a rocket could be propelled better by liquid fuel. No one had ever built a successful liquid-propellant rocket before. It was a much more difficult task than building solid-propellant rockets. Fuel and oxygen tanks, turbines, and combustion chambers would



Dr. Robert H. Goddard makes adjustments on the upper end of a rocket combustion chamber in this 1940 picture taken in Roswell, New Mexico.

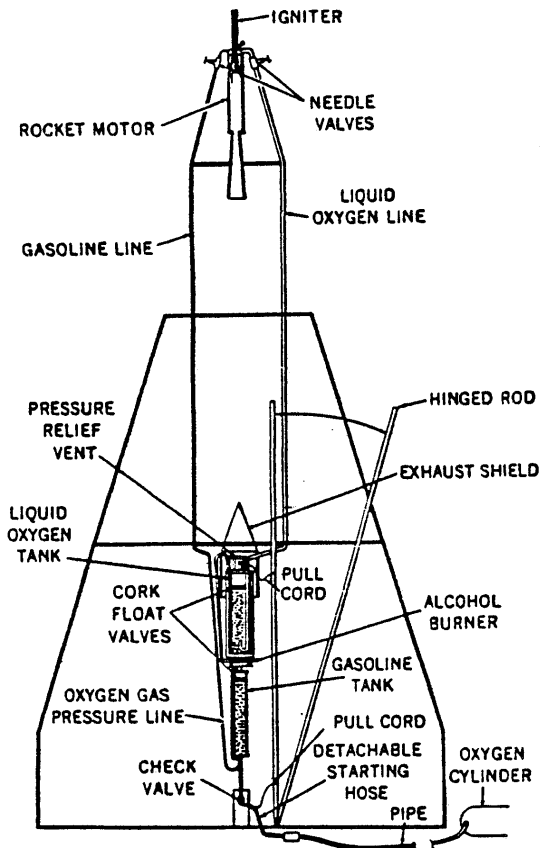

Dr. Goddard's 1926 Rocket

be needed. In spite of the difficulties, Goddard achieved the first successful flight with a liquid-propellant rocket on March 16, 1926. Fueled by liquid oxygen and gasoline, the rocket flew for only two and a half seconds, climbed 12.5 meters, and landed 56 meters away in a cabbage patch. By today's standards, the flight was unimpressive, but like the first powered airplane flight by the Wright brothers in 1903, Goddard's gasoline rocket became the forerunner of a whole new era in rocket flight.

Goddard's experiments in liquid-propellant rockets continued for many years. His rockets grew bigger and flew higher. He developed a gyroscope system for flight control and a payload compartment for scientific instruments. Parachute recovery systems returned the rockets and instruments safely to the ground. We call Goddard the father of modern rocketry for his achievements.

A third great space pioneer, Hermann Oberth (1894-1989) of Germany, published a book in 1923 about rocket travel into outer space. His writings were important. Because of them, many small rocket societies sprang up



around the world. In Germany, the formation of one such society, the Verein für Raumschiffahrt (Society for Space Travel), led to the development of the V-2 rocket, which the Germans used against London during World War II. In 1937, German engineers and scientists, including Oberth, assembled in Peenemunde on the shores of the Baltic Sea. There, under the directorship of Wernher von Braun, engineers and scientists built and flew the most advanced rocket of its time.

The V-2 rocket (in Germany called the A-4) was small by comparison to today's rockets. It achieved its great thrust by burning a mixture of liquid oxygen and alcohol at a rate of about one ton every seven seconds. Once launched, the V-2 was a formidable weapon that could devastate whole city blocks.

Fortunately for London and the Allied forces, the V-2 came too late in the war to change its outcome. Nevertheless, by war's end, German rocket scientists and engineers had already laid plans for advanced missiles capable of spanning the Atlantic Ocean and landing in the United States. These missiles would have had winged upper stages but very small payload capacities.

With the fall of Germany, the Allies captured many unused V-2 rockets and components. Many German rocket scientists came to the United States. Others went to the Soviet Union. The German scientists, including Wernher von Braun, were amazed at the progress Goddard had made.

Both the United States and the Soviet Union recognized the potential of rocketry as a military weapon and began a variety of experimental programs. At first, the United States began a program with high-altitude atmospheric sounding rockets, one of Goddard's early ideas. Later, they developed a variety of medium- and long-range intercontinental ballistic missiles. These became the starting point of the U.S. space program. Missiles such as the Redstone, Atlas, and Titan would eventually launch astronauts into space.

On October 4, 1957, the Soviet Union stunned the world by launching an Earth-orbiting artificial satellite. Called *Sputnik I*, the satellite was the first successful entry in a race for space between the two superpower nations. Less than a month later, the Soviets followed with the launch of a satellite carrying a dog named Laika on board. Laika survived in space for seven days before being put to sleep before the oxygen supply ran out.

A few months after the first *Sputnik*, the United States followed the Soviet Union with a satellite of its own. The U.S. Army

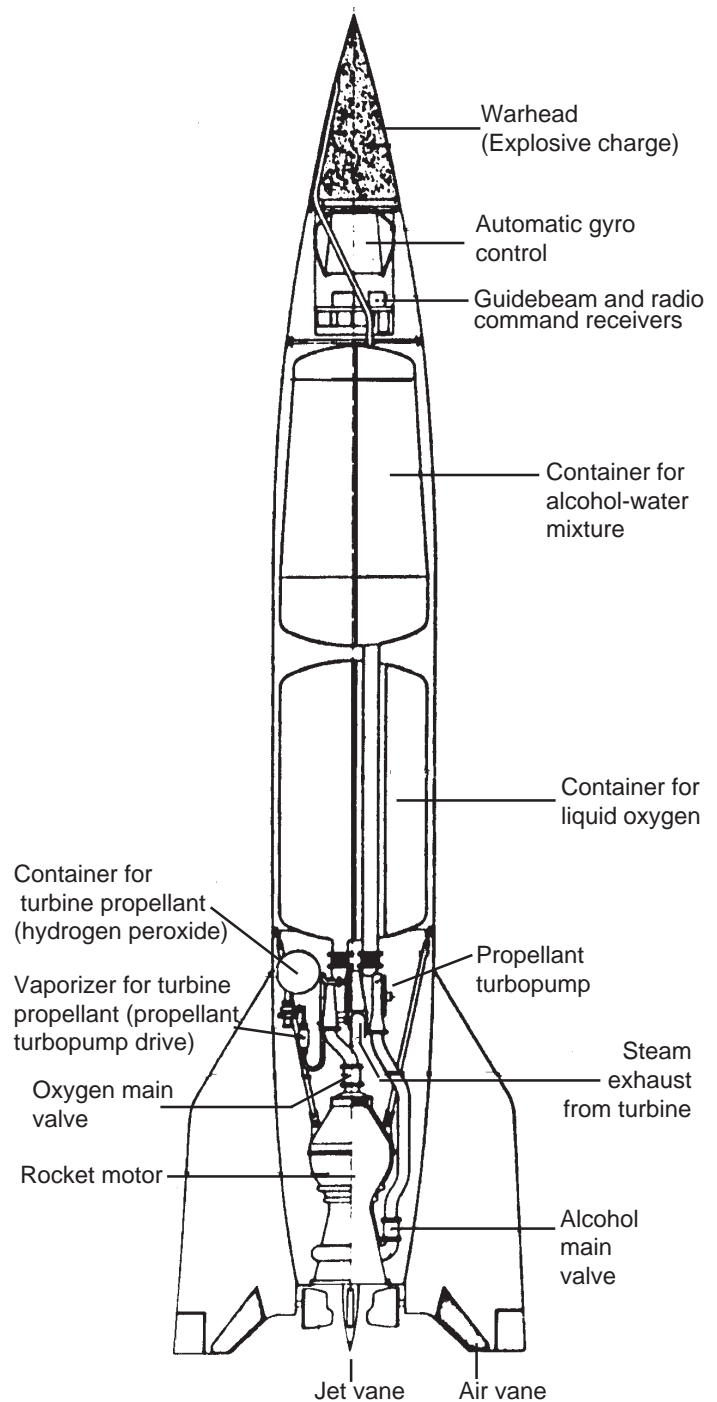

German V-2 (A-4) Missile





launched *Explorer 1* on January 31, 1958. In October of that year, the United States formally organized its space program by creating the National Aeronautics and Space Administration (NASA). NASA became a civilian agency with the goal of peaceful exploration of space for the benefit of all humankind.

Soon, rockets launched many people and machines into space. Astronauts orbited Earth and landed on the Moon. Robot spacecraft traveled to the planets. Space suddenly opened up to exploration and commercial exploitation. Satellites enabled scientists to investigate our world, forecast the weather, and communicate instantaneously around the globe. The demand for more and larger payloads created the need to develop a wide array of powerful and versatile rockets.

Scientific exploration of space using robotic spacecraft proceeded at a fast pace. Both Russia and the United States began programs to investigate the Moon. Developing the technology to physically get a probe to the Moon became the initial challenge. Within nine months of *Explorer 1* the United States launched the first unmanned lunar probe, but the launch vehicle, an Atlas with an Able upper stage, failed 45 seconds after liftoff when the payload fairing tore away from the vehicle. The Russians were more successful with *Luna 1*, which flew past the Moon in January of 1959. Later that year the *Luna* program impacted a probe on the Moon, taking the first pictures of its far side. Between 1958 and 1960 the United States sent a series of missions, the *Pioneer Lunar Probes*, to photograph and obtain scientific data about the Moon. These probes were generally unsuccessful, primarily due to launch vehicle failures. Only one of eight probes accomplished its intended mission to the Moon, though several, which were stranded in orbits between Earth and the Moon, did provide important scientific information on the number and extent of the radiation belts around Earth. The United States appeared to lag behind the Soviet Union in space.

With each launch, manned spaceflight came a step closer to becoming reality. In April of 1961, a Russian named Yuri Gagarin became the first man to orbit Earth. Less than a month later the United States launched the first American, Alan Shepard, into space. The flight was a sub-orbital lofting into space, which immediately returned to Earth. The Redstone rocket was not powerful enough to place the *Mercury* capsule into orbit. The flight lasted only a little over 15 minutes and reached an altitude of 187 kilometers. Alan Shepard experienced about

five minutes of microgravity then returned to Earth, during which he encountered forces twelve times greater than the force of gravity. Twenty days later, though still technically behind the Soviet Union, President John Kennedy announced the objective to put a man on the Moon by the end of the decade.

In February of 1962, John Glenn became the first American to orbit Earth in a small capsule so filled with equipment that he only had room to sit. Launched by the more powerful Atlas vehicle, John Glenn remained in orbit for four hours and fifty-five minutes before splashing down in the Atlantic Ocean. The *Mercury* program had a total of six launches: two suborbital and four orbital. These launches demonstrated the United States' ability to send men into orbit, allowed the crew to function in space, operate the spacecraft, and make scientific observations.

The United States then began an extensive unmanned program aimed at supporting the manned lunar landing program. Three separate projects gathered information on landing sites and other data about the lunar surface and the surrounding environment. The first was the *Ranger* series, which was the United States first attempt to

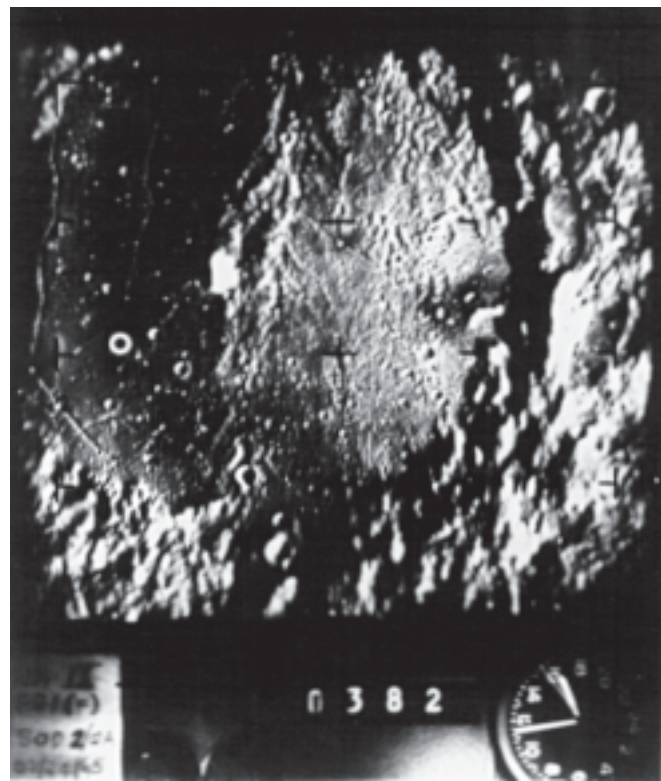

Close-up picture of the Moon taken by the *Ranger 9* spacecraft just before impact. The small circle to the left is the impact site.



take close-up photographs of the Moon. The spacecraft took thousands of black and white photographs of the Moon as it descended and crashed into the lunar surface. Though the Ranger series supplied very detailed data, mission planners for the coming *Apollo* mission wanted more extensive data.

The final two lunar programs were designed to work in conjunction with one another. *Lunar Orbiter* provided an extensive map of the lunar surface. *Surveyor* provided detailed color photographs of the lunar surface as well as data on the elements of the lunar sediment and an assessment of the ability of the sediment to support the weight of the manned landing vehicles. By examining both sets of data, planners were able to identify sites for the manned landings. However, a significant problem existed, the *Surveyor* spacecraft was too large to be launched by existing Atlas/Agona rockets, so a new high energy upper stage called the Centaur was developed to replace the Agona specifically for this mission. The Centaur upper stage used efficient hydrogen and oxygen propellants to dramatically improve its performance, but the super cold temperatures and highly explosive nature presented significant technical challenges. In addition, they built the tanks of the Centaur with thin stainless steel to save precious weight. Moderate pressure had to be maintained in the tank to prevent it from collapsing upon itself. Rocket building was refining the United State's capability to explore the Moon.

The *Gemini* was the second manned capsule developed by the United States. It was designed to carry two crew members and was launched on the largest launch vehicle available—the Titan II. President Kennedy's mandate significantly altered the *Gemini* mission from the general goal of expanding experience in space to prepare for a manned lunar landing on the Moon. It paved the way for the *Apollo* program by demonstrating rendezvous and docking required for the lunar lander to return to the lunar orbiting spacecraft, the extravehicular activity (EVA) required for the lunar surface exploration and any emergency repairs, and finally the ability of humans to function during the eight day manned lunar mission duration. The *Gemini* program launched ten manned missions in 1965 and 1966, eight flights rendezvous and docked with unmanned stages in Earth orbit and seven performed EVA.

Launching men to the moon required launch vehicles much larger than those available. To achieve this goal the United States

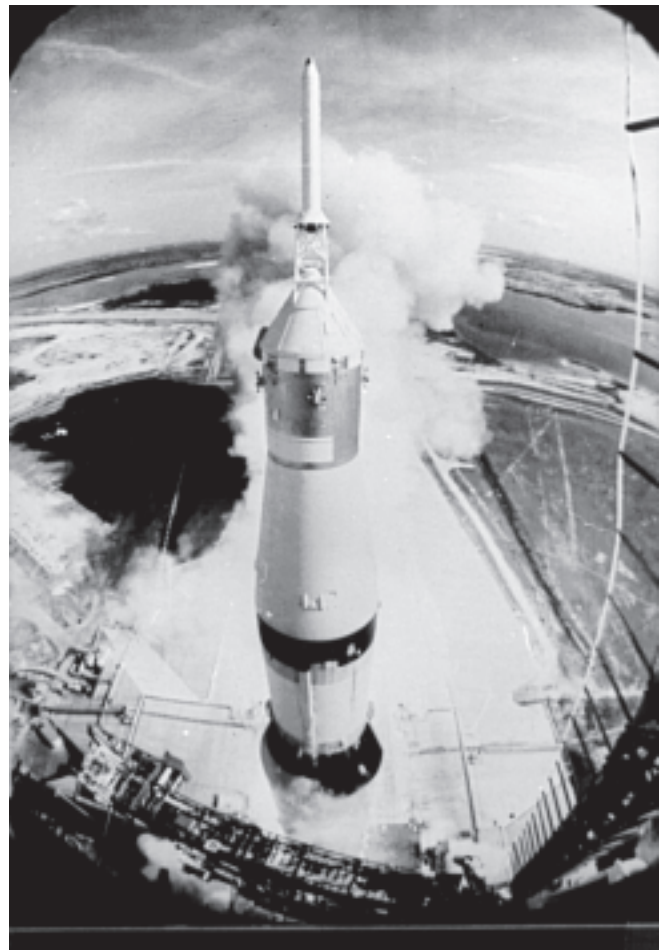

A fish-eye camera view of a Saturn 5 rocket just after engine ignition.

developed the Saturn launch vehicle. The *Apollo* capsule, or command module, held a crew of three. The capsule took the astronauts into orbit about the Moon, where two astronauts transferred into a lunar module and descended to the lunar surface. After completing the lunar mission, the upper section of the lunar module returned to orbit to rendezvous with the *Apollo* capsule. The Moonwalkers transferred back to the command module and a service module, with an engine, propelled them back to Earth. After four manned test flights, *Apollo 11* astronaut Neil Armstrong became the first man on the moon. The United States returned to the lunar surface five more times before the manned lunar program was completed. After the lunar program the *Apollo* program and the Saturn booster launched *Skylab*, the United State's first space station. A smaller version of the Saturn vehicle transported the United States' crew for the first rendezvous in space between the United States and Russia on the *Apollo-Soyuz* mission.



During this manned lunar program, unmanned launch vehicles sent many satellites to investigate our planet, forecast the weather, and communicate instantaneously around the world. In addition, scientists began to explore other planets. *Mariner 2* successfully flew by Venus in 1962, becoming the first probe to fly past another planet. The United States' interplanetary space program then took off with an amazing string of successful launches. The program has visited every planet except Pluto.

After the *Apollo* program the United States began concentrating on the development of a reusable launch system, the Space Shuttle. Solid rocket boosters and three main engines on the orbiter launch the Space Shuttle. The reusable boosters jettison little more than 2 minutes into the flight, their fuel expended. Parachutes deploy to decelerate the solid rocket boosters for a safe splashdown in the Atlantic ocean, where two ships recover them. The orbiter and external tank continue to ascend. When the main engines shut down, the external tank jettisons from the orbiter, eventually disintegrating in the atmosphere. A brief firing of the spacecraft's two orbital maneuvering system thrusters changes the trajectory to achieve orbit at a range of 185-402 kilometers above Earth's surface. The Space Shuttle orbiter can carry approximately 25,000 kilograms of payload into orbit so crew members can conduct experiments in a microgravity environment. The orbital maneuvering system thrusters fire to slow the spacecraft for reentry into Earth's atmosphere, heating up the orbiter's thermal protection shield up to 816° Celsius. On the Shuttle's final descent, it returns to Earth gliding like an airplane.

Since the earliest days of discovery and experimentation, rockets have evolved from simple gunpowder devices into giant vehicles capable of traveling into outer space, taking astronauts to the Moon, launching satellites to explore our universe, and enabling us to conduct scientific experiments aboard the Space Shuttle. Without a doubt rockets have opened the universe to direct exploration by humankind. What role will rockets play in our future?

The goal of the United States space program is to expand our horizons in space, and then to open the space frontier to international human expansion and the commercial development. For

this to happen, rockets must become more cost effective and more reliable as a means of getting to space. Expensive hardware cannot be thrown away each time we go to space. It is necessary to continue the drive for more reusability started during the Space Shuttle program. Eventually NASA may develop aerospace planes that will take off from runways, fly into orbit, and land on those same runways, with operations similar to airplanes.

To achieve this goal two programs are currently under development. The X33 and X34 programs will develop reusable vehicles, which significantly decrease the cost to orbit. The X33 will be a manned vehicle lifting about the same payload capacity as the Space Shuttle. The X34 will be a small, reusable unmanned launch vehicle capable of launching 905 kilograms to space and reduce the launch cost relative to current vehicles by two thirds.

The first step towards building fully reusable vehicles has already occurred. A project called the Delta Clipper is currently being tested. The Delta Clipper is a vertical takeoff and soft landing vehicle. It has demonstrated the ability to hover and maneuver over Earth using the same hardware over and over again. The program uses much existing technology and minimizes the operating cost. Reliable, inexpensive rockets are the key to enabling humans to truly expand into space.



Three reusable future space vehicle concepts under consideration by NASA.



# Rocket Principles

A rocket in its simplest form is a chamber enclosing a gas under pressure. A small opening at one end of the chamber allows the gas to escape, and in doing so provides a thrust that propels the rocket in the opposite direction. A good example of this is a balloon. Air inside a balloon is compressed by the balloon's rubber walls. The air pushes back so that the inward and outward pressing forces balance. When the nozzle is released, air escapes through it and the balloon is propelled in the opposite direction.

When we think of rockets, we rarely think of balloons. Instead, our attention is drawn to the giant vehicles that carry satellites into orbit and spacecraft to the Moon and planets. Nevertheless, there is a strong similarity between the two.

The only significant difference is the way the pressurized gas is produced. With space rockets, the gas is produced by burning propellants that can be solid or liquid in form or a combination of the two.

One of the interesting facts about the historical development of rockets is that while rockets and rocket-powered devices have been in use for more than two thousand years, it has been only in the last three hundred years that rocket experimenters have had a scientific basis for understanding how they work.

The science of rocketry began with the publishing of a book in 1687 by the great English scientist Sir Isaac Newton. His book, entitled *Philosophiae Naturalis Principia Mathematica*, described physical principles in nature. Today, Newton's work is usually just called the *Principia*.

In the *Principia*, Newton stated three important scientific principles that govern the motion of all objects, whether on Earth or in space. Knowing these principles, now called Newton's Laws of Motion, rocketeers have been able to construct the modern giant rockets of the 20th century such as the Saturn 5 and the Space Shuttle. Here now, in simple form, are Newton's Laws of Motion.

1. Objects at rest will stay at rest and objects in motion will stay in motion in a straight line unless acted upon by an unbalanced force.

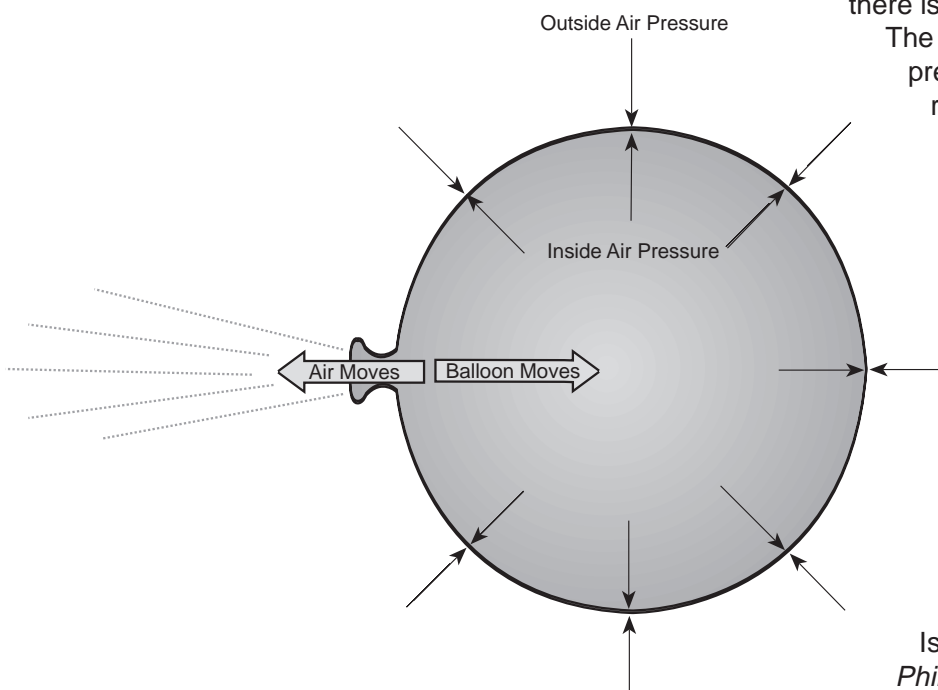

2. Force is equal to mass times acceleration.
3. For every action there is always an opposite and equal reaction.

As will be explained shortly, all three laws are really simple statements of how things move. But with them, precise determinations of rocket performance can be made.

### Newton's First Law

This law of motion is just an obvious statement of fact, but to know what it means, it is necessary to understand the terms *rest*, *motion*, and *unbalanced force*.

Rest and motion can be thought of as being opposite to each other. Rest is the state of an object when it is not changing position in relation to its surroundings. If you are sitting still in a chair, you can be said to be at rest. This term, however, is relative. Your chair may actually be one of many seats on a speeding airplane. The important thing to remember here is that you are not moving *in relation to your immediate surroundings*. If rest were defined as a total absence of motion, it would not exist in nature. Even if you were sitting in your chair at home, you would still be moving, because your chair is actually sitting on the surface of a spinning planet that is orbiting a star. The star is moving through a rotating galaxy that is, itself, moving through the universe. While sitting "still," you are, in fact, traveling at a speed of hundreds of kilometers per second.

Motion is also a relative term. All matter in the universe is moving all the time, but in the first law, motion here means changing position in relation to surroundings. A ball is at rest if it is sitting on the ground. The ball is in motion if it is rolling. A rolling ball changes its position in relation to its surroundings. When you are sitting on a chair in an airplane, you are at rest, but if you get up and walk down the aisle, you are in motion. A rocket blasting off the launch pad changes from a state of rest to a state of motion.

The third term important to understanding this law is unbalanced force. If you hold a ball in your hand and keep it still, the ball is at rest. All the time the ball is held there though, it is being acted upon by forces. The force of gravity is trying to pull the ball downward, while at the same time your hand is pushing against the ball to hold it up. The forces acting on the ball are balanced. Let the ball go, or move your hand upward, and the forces

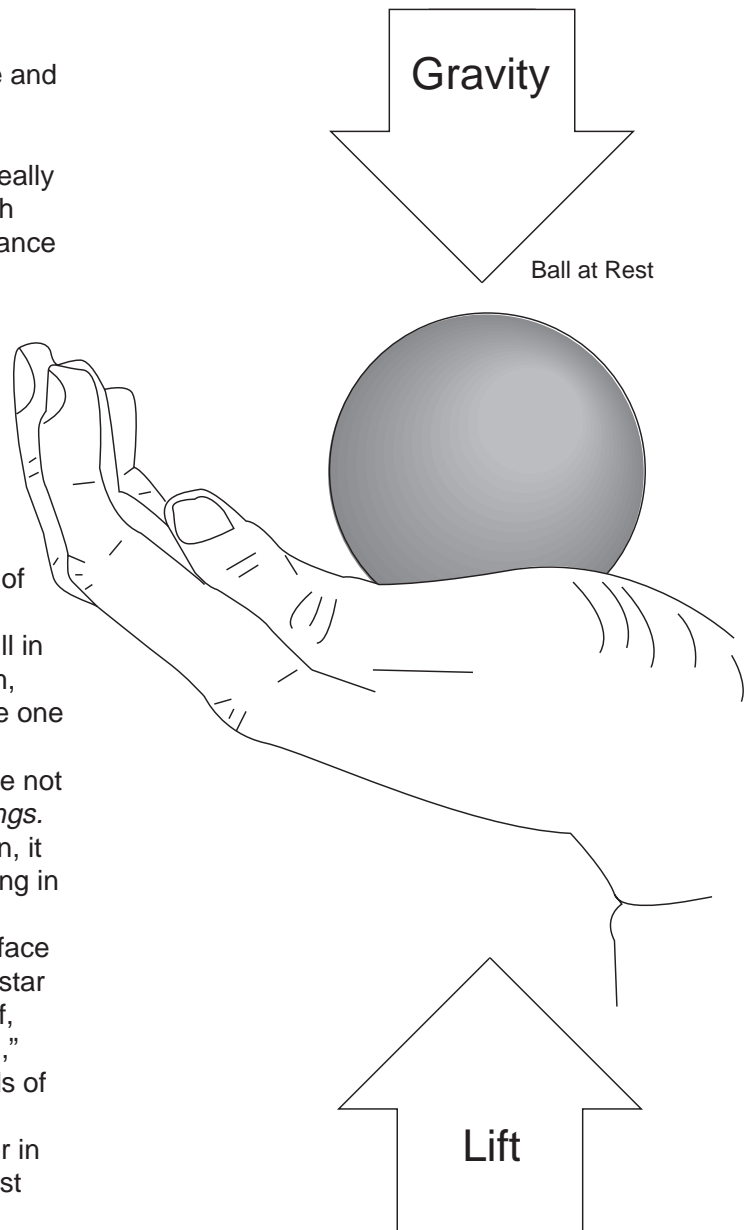

become unbalanced. The ball then changes from a state of rest to a state of motion.

In rocket flight, forces become balanced and unbalanced all the time. A rocket on the launch pad is balanced. The surface of the pad pushes the rocket up while gravity tries to pull it down. As the engines are ignited, the thrust from the rocket unbalances the forces, and the rocket travels upward. Later, when the rocket runs out of fuel, it slows down, stops at the highest point of its flight, and then falls back to Earth.

Objects in space also react to forces. A spacecraft moving through the solar system is in constant motion. The spacecraft will travel



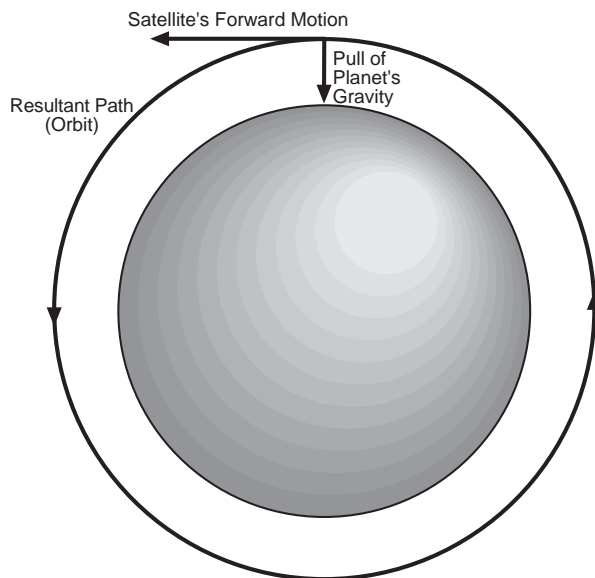

The combination of a satellite's forward motion and the pull of gravity of the planet, bend the satellite's path into an orbit.

in a straight line if the forces on it are in balance. This happens only when the spacecraft is very far from any large gravity source such as Earth or the other planets and their moons. If the spacecraft comes near a large body in space, the gravity of that body will unbalance the forces and curve the path of the spacecraft. This happens, in particular, when a satellite is sent by a rocket on a path that is tangent to the planned orbit about a planet. The unbalanced gravitational force causes the satellite's path to change to an arc. The arc is a combination of the satellite's fall inward toward the planet's center and its forward motion. When these two motions are just right, the shape of the satellite's path matches the shape of the body it is traveling around. Consequently, an orbit is produced. Since the gravitational force changes with height above a planet, each altitude has its own unique velocity that results in a circular orbit. Obviously, controlling velocity is extremely important for maintaining the circular orbit of the spacecraft. Unless another unbalanced force, such as friction with gas

molecules in orbit or the firing of a rocket engine in the opposite direction, slows down the spacecraft, it will orbit the planet forever.

Now that the three major terms of this first law have been explained, it is possible to restate this law. If an object, such as a rocket, is at rest, it takes an unbalanced force to make it move. If the object is already moving, it takes an unbalanced force, to stop it, change its direction from a straight line path, or alter its speed.

### Newton's Third Law

For the time being, we will skip the Second Law and go directly to the Third. This law states that every action has an equal and opposite reaction. If you have ever stepped off a small boat that has not been properly tied to a pier, you will know exactly what this law means.

A rocket can liftoff from a launch pad only when it expels gas out of its engine. The rocket pushes on the gas, and the gas in turn pushes on the rocket. The whole process is very similar to riding a skateboard. Imagine that a skateboard and rider are in a state of rest (not moving). The rider jumps off the skateboard. In the Third Law, the jumping is called an *action*. The skateboard responds to that action by traveling some distance in the opposite direction. The skateboard's opposite motion is called a *reaction*. When the distance traveled by the rider and the skateboard are compared, it would appear that the skateboard has had a much greater reaction than the action of the rider. This is not the case. The reason the

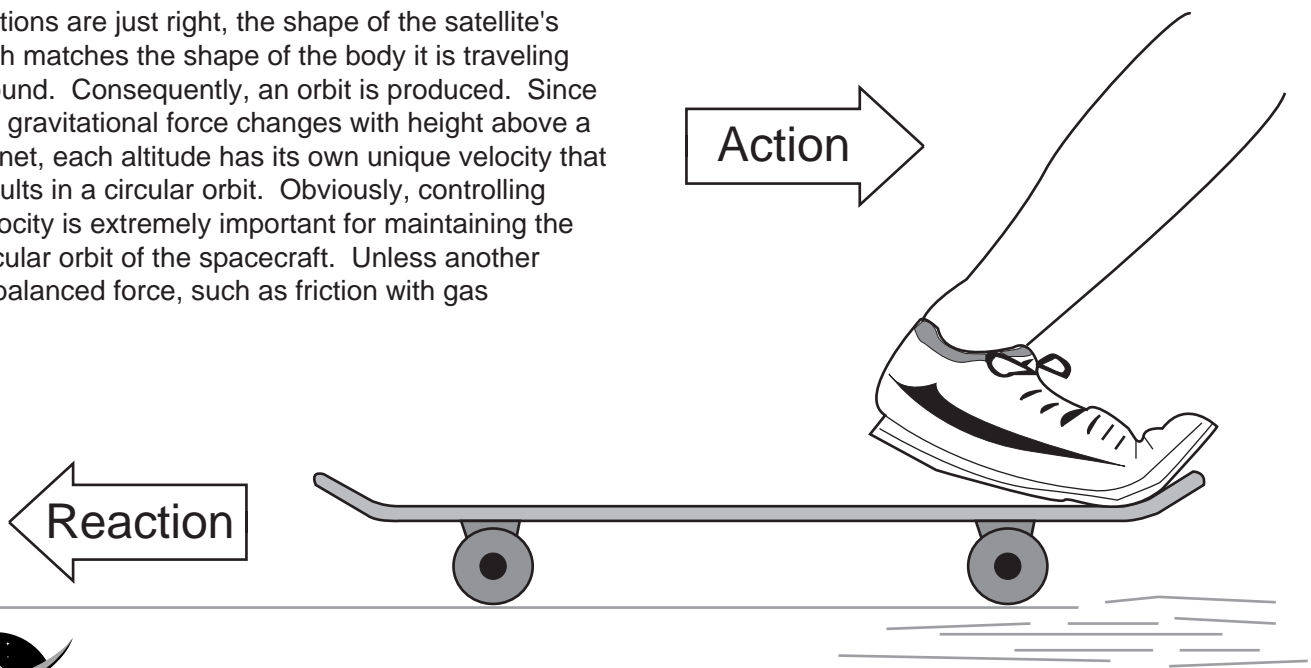

skateboard has traveled farther is that it has less mass than the rider. This concept will be better explained in a discussion of the Second Law.

With rockets, the action is the expelling of gas out of the engine. The reaction is the movement of the rocket in the opposite direction. To enable a rocket to lift off from the launch pad, the action, or thrust, from the engine must be greater than the weight of the rocket. While on the pad the weight of the rocket is balanced by the force of the ground pushing against it. Small amounts of thrust result in less force required by the ground to keep the rocket balanced. Only when the thrust is greater than the weight of the rocket does the force become unbalanced and the rocket lifts off. In space where unbalanced force is used to maintain the orbit, even tiny thrusts will cause a change in the unbalanced force and result in the rocket changing speed or direction.

One of the most commonly asked questions about rockets is how they can work in space where there is no air for them to push against. The answer to this question comes from the Third Law. Imagine the skateboard again. On the ground, the only part air plays in the motions of the rider and the skateboard is to slow them down. Moving through the air causes friction, or as scientists call it, *drag*. The surrounding air impedes the action-reaction.

As a result rockets actually work better in space than they do in air. As the exhaust gas leaves the rocket engine it must push away the surrounding air; this uses up some of the energy of the rocket. In space, the exhaust gases can escape freely.

### Newton's Second Law

This law of motion is essentially a statement of a mathematical equation. The three parts of the equation are mass (m), acceleration (a), and force (f). Using letters to symbolize each part, the equation can be written as follows:

$$f = ma$$

The equation reads: force equals mass times acceleration. To explain this law, we will use an old style cannon as an example.

When the cannon is fired, an explosion propels a cannon ball out the open end of the barrel. It flies a kilometer or two to its target. At the same time the

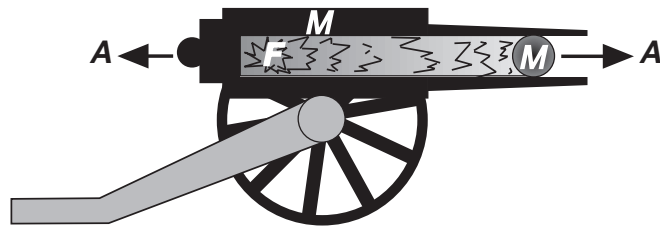

cannon itself is pushed backward a meter or two. This is action and reaction at work (Third Law). The force acting on the cannon and the ball is the same. What happens to the cannon and the ball is determined by the Second Law. Look at the two equations below.

$$f = m_{(cannon)} a_{(cannon)}$$

$$f = m_{(ball)} a_{(ball)}$$

The first equation refers to the cannon and the second to the cannon ball. In the first equation, the mass is the cannon itself and the acceleration is the movement of the cannon. In the second equation the mass is the cannon ball and the acceleration is its movement. Because the force (exploding gun powder) is the same for the two equations, the equations can be combined and rewritten below.

$$m_{(cannon)} a_{(cannon)} = m_{(ball)} a_{(ball)}$$

In order to keep the two sides of the equations equal, the accelerations vary with mass. In other words, the cannon has a large mass and a small acceleration. The cannon ball has a small mass and a large acceleration.

Apply this principle to a rocket. Replace the mass of the cannon ball with the mass of the gases being ejected out of the rocket engine. Replace the mass of the cannon with the mass of the rocket moving in the other direction. Force is the pressure created by the controlled explosion taking place inside the rocket's engines. That pressure accelerates the gas one way and the rocket the other.

Some interesting things happen with rockets that do not happen with the cannon and ball in this example. With the cannon and cannon ball, the thrust lasts for just a moment. The thrust for the rocket continues as long as its engines are



firing. Furthermore, the mass of the rocket changes during flight. Its mass is the sum of all its parts. Rocket parts include: engines, propellant tanks, payload, control system, and propellants. By far, the largest part of the rocket's mass is its propellants. But that amount constantly changes as the engines fire. That means that the rocket's mass gets smaller during flight. In order for the left side of our equation to remain in balance with the right side, acceleration of the rocket has to increase as its mass decreases. That is why a rocket starts off moving slowly and goes faster and faster as it climbs into space.

Newton's Second Law of Motion is especially useful when designing efficient rockets. To enable a rocket to climb into low Earth orbit, it is necessary to achieve a speed, in excess of 28,000 km per hour. A speed of over 40,250 km per hour, called *escape velocity*, enables a rocket to leave Earth and travel out into deep space. Attaining space flight speeds requires the rocket engine to achieve the greatest action force possible in the shortest time. In other words, the engine must burn a large mass of fuel and push the resulting gas out of the engine as rapidly as possible. Ways of doing this will be described in the next chapter.

Newton's Second Law of Motion can be restated in the following way: the greater the mass of rocket fuel burned, and the faster the gas produced can escape the engine, the greater the thrust of the rocket.

## Putting Newton's Laws of Motion Together

An unbalanced force must be exerted for a rocket to lift off from a launch pad or for a craft in space to change speed or direction (First Law). The amount of thrust (force) produced by a rocket engine will be determined by the rate at which the mass of the rocket fuel burns and the speed of the gas escaping the rocket (Second Law). The reaction, or motion, of the rocket is equal to and in the opposite direction of the action, or thrust, from the engine (Third Law).





# Practical Rocketry

The first rockets ever built, the fire-arrows of the Chinese, were not very reliable. Many just exploded on launching. Others flew on erratic courses and landed in the wrong place. Being a rocketeer in the days of the fire-arrows must have been an exciting, but also a highly dangerous activity.

Today, rockets are much more reliable. They fly on precise courses and are capable of going fast enough to escape the gravitational pull of Earth. Modern rockets are also more efficient today because we have an understanding of the scientific principles behind rocketry. Our understanding has led us to develop a wide variety of advanced rocket hardware and devise new propellants that can be used for longer trips and more powerful takeoffs.

## Rocket Engines and Their Propellants

Most rockets today operate with either solid or liquid propellants. The word *propellant* does not mean simply fuel, as you might think; it means both *fuel* and *oxidizer*. The fuel is the chemical the rocket burns but, for burning to take place, an oxidizer (oxygen) must be present. Jet engines draw oxygen into their engines from the surrounding air. Rockets do not have the luxury that jet planes have; they must carry oxygen with them into space, where there is no air.

Solid rocket propellants, which are dry to the touch, contain both the fuel and oxidizer combined together in the chemical itself. Usually the fuel is a mixture of hydrogen compounds and carbon and the oxidizer is made up of oxygen compounds. Liquid propellants, which are often gases that have been chilled until they turn into liquids, are kept in separate containers, one for the fuel and the other for the oxidizer. Just before firing, the fuel and oxidizer are mixed together in the engine.

A *solid-propellant rocket* has the simplest form of engine. It has a *nozzle*, a *case*, *insulation*, *propellant*, and an *igniter*. The case of the engine is usually a relatively thin metal that is lined with insulation to keep the propellant from burning through. The propellant itself is packed inside the insulation layer.

Many solid-propellant rocket engines feature a hollow core that runs through the propellant. Rockets that do not have the hollow core must be ignited at the lower end of the propellants and burning proceeds gradually from one end of the rocket to the other. In all cases, only the surface of the propellant burns. However, to get higher thrust, the hollow core is used. This increases the



surface of the propellants available for burning. The propellants burn from the inside out at a much higher rate, sending mass out the nozzle at a higher rate and speed. This results in greater thrust. Some propellant cores are star shaped to increase the burning surface even more.

To ignite solid propellants, many kinds of igniters can be used. Fire-arrows were ignited by fuses, but sometimes these ignited too quickly and burned the rocketeer. A far safer and more reliable form of ignition used today is one that employs electricity. An electric current, coming through wires from some distance away, heats up a special wire inside the rocket. The wire raises the temperature of the propellant it is in contact with to the combustion point.

Other igniters are more advanced than the hot wire device. Some are encased in a chemical that ignites first, which then ignites the propellants. Still other igniters, especially those for large rockets, are rocket engines themselves. The small engine inside the hollow core blasts a stream of flames and hot gas down from the top of the core and ignites the entire surface area of the propellants in a fraction of a second.

The nozzle in a solid-propellant engine is an opening at the back of the rocket that permits the hot expanding gases to escape. The narrow part of the nozzle is the *throat*. Just beyond the throat is the exit cone.

The purpose of the nozzle is to increase the acceleration of the gases as they leave the rocket and thereby maximize the thrust. It does this by cutting down the opening through which the gases can escape. To see how this works, you can experiment with a garden hose that has a spray nozzle attachment. This kind of nozzle does not have an exit cone, but that does not matter in the experiment. The important point about the nozzle is that the size of the opening can be varied.

Start with the opening at its widest point. Watch how far the water squirts and feel the thrust produced by the departing water. Now reduce the diameter of the opening, and again note the distance the water squirts and feel the thrust. Rocket nozzles work the same way.

As with the inside of the rocket case, insulation is needed to protect the nozzle from the hot gases. The usual insulation is one that gradually erodes as the gas passes through. Small pieces of the insulation get very hot and break away from the nozzle. As they are blown away, heat is carried away with them.

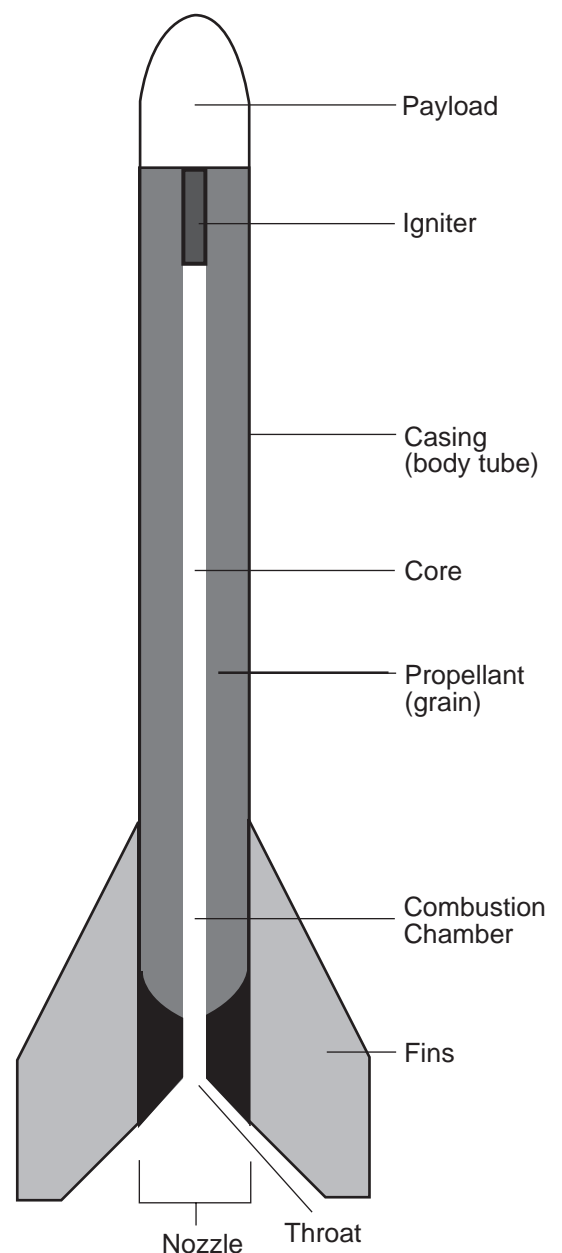

Solid Propellant Rocket

The other main kind of rocket engine is one that uses liquid propellants, which may be either pumped or fed into the engine by pressure. This is a much more complicated engine, as is evidenced by the fact that solid rocket engines were used for at least seven hundred years before the first successful liquid engine was tested. Liquid propellants have separate storage tanks—one for the fuel and one for the oxidizer. They also have a *combustion chamber*, and a nozzle.



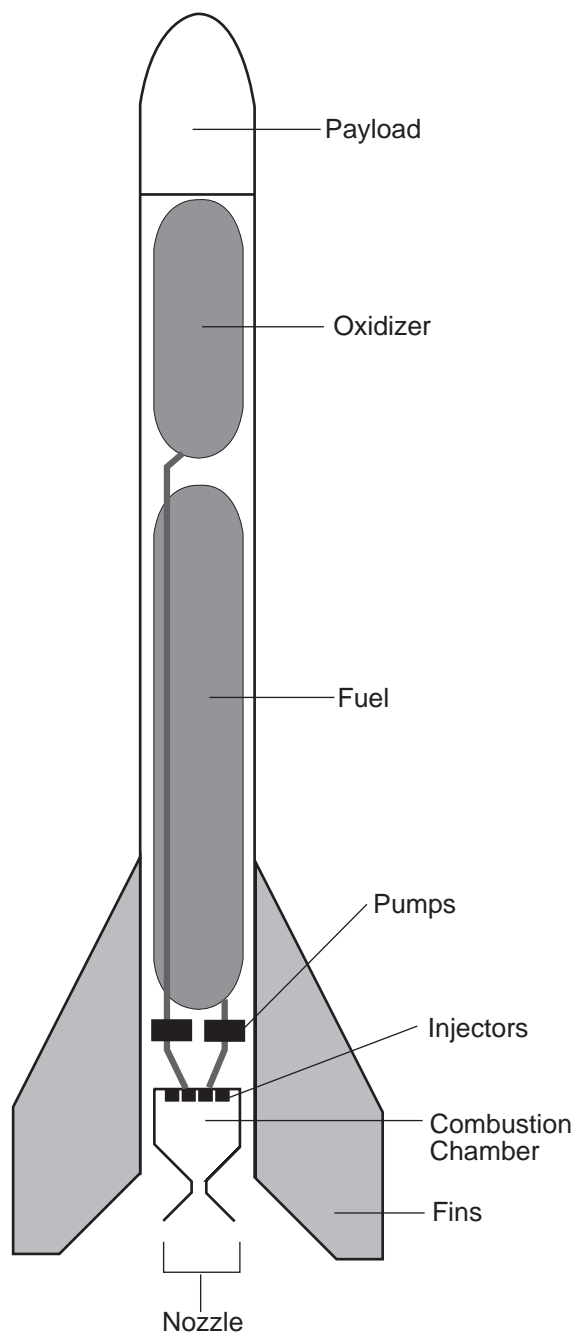

Liquid Propellant Rocket

The fuel of a liquid-propellant rocket is usually kerosene or liquid hydrogen; the oxidizer is usually liquid oxygen. They are combined inside a cavity called the combustion chamber. Here the propellants burn and build up high temperatures and pressures, and the expanding gas escapes through the nozzle at the lower end. To get the most power from the propellants, they must be mixed as completely as possible. Small *injectors* (nozzles) on the roof of the chamber spray and mix the propellants at the same time. Because the

chamber operates under high pressures, the propellants need to be forced inside. Modern liquid rockets use powerful, lightweight turbine pumps to take care of this job.

With any rocket, and especially with liquid-propellant rockets, weight is an important factor. In general, the heavier the rocket, the more the thrust needed to get it off the ground. Because of the pumps and fuel lines, liquid engines are much heavier than solid engines.

One especially good method of reducing the weight of liquid engines is to make the exit cone of the nozzle out of very lightweight metals. However, the extremely hot, fast-moving gases that pass through the cone would quickly melt thin metal. Therefore, a cooling system is needed. A highly effective though complex cooling system that is used with some liquid engines takes advantage of the low temperature of liquid hydrogen. Hydrogen becomes a liquid when it is chilled to  $-253^{\circ}\text{C}$ . Before injecting the hydrogen into the combustion chamber, it is first circulated through small tubes that lace the walls of the exit cone. In a cutaway view, the exit cone wall looks like the edge of corrugated cardboard. The hydrogen in the tubes absorbs the excess heat entering the cone walls and prevents it from melting the walls away. It also makes the hydrogen more energetic because of the heat it picks up. We call this kind of cooling system *regenerative cooling*.

### Engine Thrust Control

Controlling the thrust of an engine is very important to launching payloads (cargoes) into orbit. Thrusting for too short or too long of a period of time will cause a satellite to be placed in the wrong orbit. This could cause it to go too far into space to be useful or make the satellite fall back to Earth. Thrusting in the wrong direction or at the wrong time will also result in a similar situation.

A computer in the rocket's guidance system determines when that thrust is needed and turns the engine on or off appropriately. Liquid engines do this by simply starting or stopping the flow of propellants into the combustion chamber. On more complicated flights, such as going to the Moon, the engines must be started and stopped several times.

Some liquid-propellant engines control the amount of engine thrust by varying the amount of propellant that enters the combustion chamber. Typically the engine thrust varies for controlling the acceleration experienced by astronauts or to limit the aerodynamic forces on a vehicle.



Solid-propellant rockets are not as easy to control as liquid rockets. Once started, the propellants burn until they are gone. They are very difficult to stop or slow down part way into the burn. Sometimes fire extinguishers are built into the engine to stop the rocket in flight. But using them is a tricky procedure and does not always work. Some solid-fuel engines have hatches on their sides that can be cut loose by remote control to release the chamber pressure and terminate thrust.

The burn rate of solid propellants is carefully planned in advance. The hollow core running the length of the propellants can be made into a star shape. At first, there is a very large surface available for burning, but as the points of the star burn away, the surface area is reduced. For a time, less of the propellant burns, and this reduces thrust. The *Space Shuttle* uses this technique to reduce vibrations early in its flight into orbit.

NOTE: Although most rockets used by governments and research organizations are very reliable, there is still great danger associated with the building and firing of rocket engines. Individuals interested in rocketry should **never** attempt to build their own engines. Even the simplest-looking rocket engines are very complex. Case-wall bursting strength, propellant packing density, nozzle design, and propellant chemistry are all design problems beyond the scope of most amateurs. Many home-built rocket engines have exploded in the faces of their builders with tragic consequences.

### Stability and Control Systems

Building an efficient rocket engine is only part of the problem in producing a successful rocket. The rocket must also be stable in flight. A stable rocket is one that flies in a smooth, uniform direction. An unstable rocket flies along an erratic path, sometimes tumbling or changing direction. Unstable rockets are dangerous because it is not possible to predict where they will go. They may even turn upside down and suddenly head back directly to the launch pad.

Making a rocket stable requires some form of control system. Controls can be either active or passive. The difference between these and how they work will be explained later. It is first important to understand what makes a rocket stable or unstable.

All matter, regardless of size, mass, or shape, has a point inside called the *center of mass* (CM). The center of mass is the exact

spot where all of the mass of that object is perfectly balanced. You can easily find the center of mass of an object such as a ruler by balancing the object on your finger. If the material used to make the ruler is of uniform thickness and density, the center of mass should be at the halfway point between one end of the stick and the other. If the ruler were made of wood, and a heavy nail were driven into one of its ends, the center of mass would no longer be in the middle. The balance point would then be nearer the end with the nail.

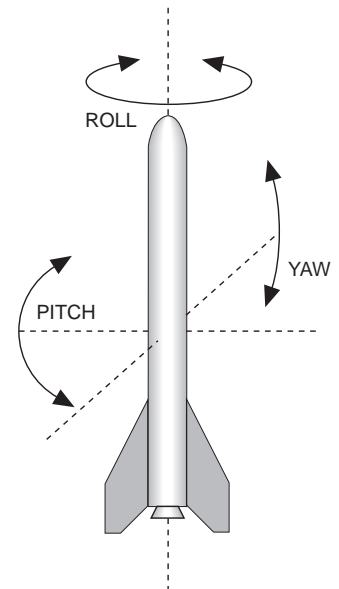

The center of mass is important in rocket flight because it is around this point that an unstable rocket tumbles. As a matter of fact, any object in flight tends to tumble. Throw a stick, and it tumbles end over end. Throw a ball, and it spins in flight. The act of spinning or tumbling is a way of becoming stabilized in flight. A Frisbee will go where you want it to only if you throw it with a deliberate spin. Try throwing a Frisbee without spinning it. If you succeed, you will see that the Frisbee flies in an erratic path and falls far short of its mark.

In flight, spinning or tumbling takes place around one or more of three axes. They are called *roll*, *pitch*, and *yaw*. The point where all three of these axes intersect is the center of mass. For

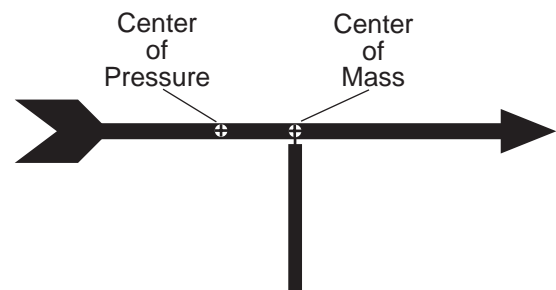

rocket flight, the pitch and yaw axes are the most important because any movement in either of these two directions can cause the rocket to go off course. The roll axis is the least important because movement along this axis will not affect the flight path. In fact, a rolling motion will help stabilize the



rocket in the same way a properly passed football is stabilized by rolling (spiraling) it in flight. Although a poorly passed football may still fly to its mark even if it tumbles rather than rolls, a rocket will not. The action-reaction energy of a football pass will be completely expended by the thrower the moment the ball leaves the hand. With rockets, thrust from the engine is still being produced while the rocket is in flight. Unstable motions about the pitch and yaw axes will cause the rocket to leave the planned course. To prevent this, a control system is needed to prevent or at least minimize unstable motions.

In addition to center of mass, there is another important center inside the rocket that affects its flight. This is the *center of pressure* (CP). The center of pressure exists only when air is flowing past the moving rocket. This flowing air, rubbing and pushing against the outer surface of the rocket, can cause it to begin moving around one of its three axes. Think for a moment of a weather vane. A weather vane is an arrow-like stick that is mounted on a rooftop and used for telling wind direction. The arrow is attached to a vertical rod that acts as a pivot point. The arrow is balanced so that the center of mass is right at the pivot point. When the wind blows, the arrow turns, and the head of the arrow points into the oncoming wind. The tail of the arrow points in the downwind direction.

The reason that the weather vane arrow points into the wind is that the tail of the arrow has a much larger surface area than the arrowhead. The flowing air imparts a greater force to the tail than the head, and therefore the tail is pushed away. There is a point on the arrow where the surface area is the same on one side as the other. This spot is called the center of pressure. The center of pressure is not in the same place as the center of mass. If it were, then neither end of the arrow would be favored by the wind and the arrow would not point. The center of pressure is between the center of mass and the tail end of the arrow. This means that the tail end has more surface area than the head end.

It is extremely important that the center of pressure in a rocket be located toward the tail and the center of mass be located toward the nose. If they are in the same place or very near each other, then the rocket will be unstable in flight. The rocket will then try to rotate about the center of mass in the pitch and yaw axes, producing a dangerous situation. With the center of pressure located in the right place, the rocket will remain stable.

Control systems for rockets are intended to keep a rocket stable in flight and to steer it. Small

rockets usually require only a stabilizing control system. Large rockets, such as the ones that launch satellites into orbit, require a system that not only stabilizes the rocket, but also enable it to change course while in flight.

Controls on rockets can either be active or passive. *Passive controls* are fixed devices that keep rockets stabilized by their very presence on the rocket's exterior. *Active controls* can be moved while the rocket is in flight to stabilize and steer the craft.

The simplest of all passive controls is a stick. The Chinese fire-arrows were simple rockets mounted on the ends of sticks. The stick kept the center of pressure behind the center of mass. In spite of this, fire-arrows were notoriously inaccurate. Before the center of pressure could take effect, air had to be flowing past the rocket. While still on the ground and immobile, the arrow might lurch and fire the wrong way.

Years later, the accuracy of fire-arrows was improved considerably by mounting them in a trough aimed in the proper direction. The trough

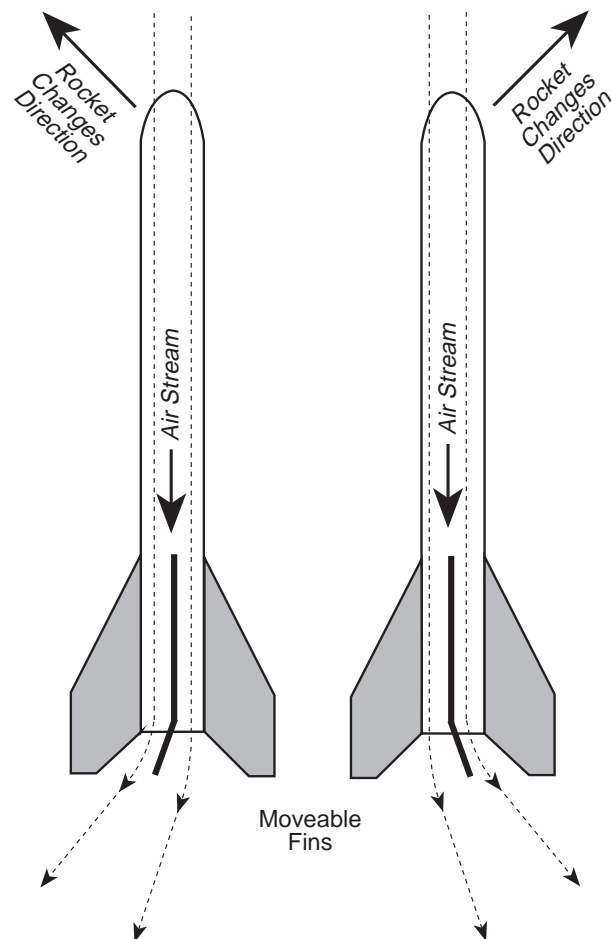

guided the arrow in the right direction until it was moving fast enough to be stable on its own.

As will be explained in the next section, the weight of the rocket is a critical factor in performance and range. The fire-arrow stick added too much dead weight to the rocket, and therefore limited its range considerably.

An important improvement in rocketry came with the replacement of sticks by clusters of lightweight fins mounted around the lower end near the nozzle. Fins could be made out of lightweight materials and be streamlined in shape. They gave rockets a dart-like appearance. The large surface area of the fins easily kept the center of pressure behind the center of mass. Some experimenters even bent the lower tips of the fins in a pinwheel fashion to promote rapid spinning in flight. With these "spin fins," rockets become much more stable in flight. But this design also produces more drag and limits the rocket's range.

With the start of modern rocketry in the 20th century, new ways were sought to improve rocket stability and at the same time reduce overall rocket

weight. The answer to this was the development of active controls. Active control systems included *vanes*, *movable fins*, *canards*, *gimbaled nozzles*, *vernier rockets*, *fuel injection*, and *attitude-control rockets*. Tilting fins and canards are quite similar to each other in appearance. The only real difference between them is their location on the rockets. Canards are mounted on the front end of the rocket while the tilting fins are at the rear. In flight, the fins and canards tilt like rudders to deflect the air flow and cause the rocket to change course. Motion sensors on the rocket detect unplanned directional changes, and corrections can be made by slight tilting of the fins and canards. The advantage of these two devices is size and weight. They are smaller and lighter and produce less drag than the large fins.

Other active control systems can eliminate fins and canards altogether. By tilting the angle at which the exhaust gas leaves the rocket engine, course changes can be made in flight. Several techniques can be used for changing exhaust direction.

Vanes are small finlike devices that are placed inside the exhaust of the rocket engine. Tilting the vanes deflects the exhaust, and by action-reaction the rocket responds by pointing the opposite way.

Another method for changing the exhaust direction is to gimbal the nozzle. A gimbaled nozzle is one that is able to sway while exhaust gases are passing through it. By tilting the engine nozzle in the proper direction, the rocket responds by changing course.

Vernier rockets can also be used to change direction. These are small rockets mounted on the outside of the large engine. When needed they fire, producing the desired course change.

In space, only by spinning the rocket along the roll axis or by using active controls involving the engine exhaust can the rocket be stabilized or have its direction changed. Without air, fins and canards have nothing to work upon. (Science fiction movies showing rockets in space with wings and fins are long on fiction and short on science.) While coasting in space, the most common kinds of active control used are attitude-control rockets. Small clusters of engines are mounted all around the vehicle. By firing the right combination of these small rockets, the vehicle can be turned in any direction. As soon as they are aimed properly, the main engines fire, sending the rocket off in the new direction.

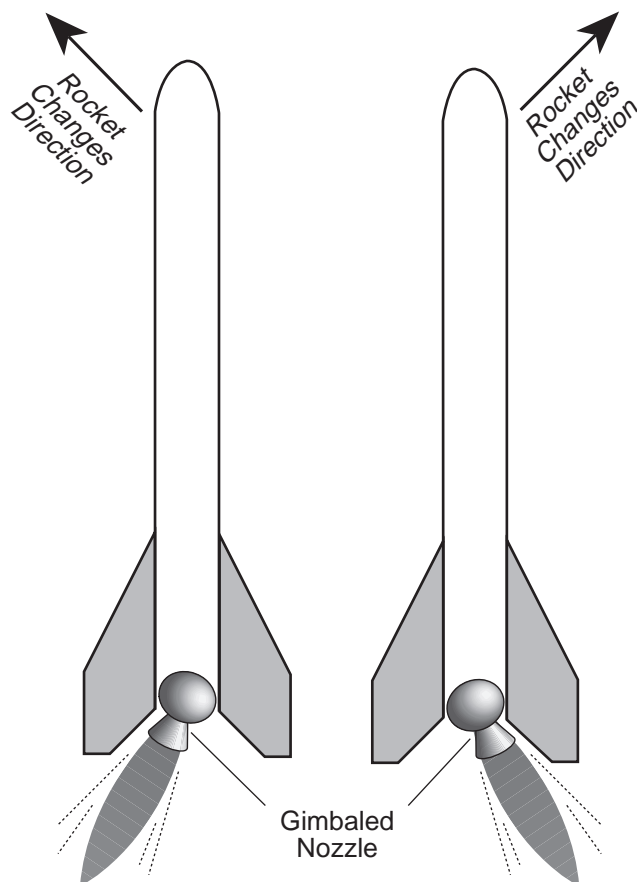

## Mass

Mass is another important factor affecting the performance of a rocket. The mass of a rocket can make the difference between a successful flight and just wallowing around on the launch pad. As a basic principle of rocket flight, it can be said that for a rocket to leave the ground, the engine must produce a thrust that is greater than the total mass of the vehicle. It is obvious that a rocket with a lot of unnecessary mass will not be as efficient as one that is trimmed to just the bare essentials.

For an ideal rocket, the total mass of the vehicle should be distributed following this general formula:

Of the total mass, 91 percent should be propellants; 3 percent should be tanks, engines, fins, etc.; and 6 percent can be the payload.

Payloads may be satellites, astronauts, or spacecraft that will travel to other planets or moons.

In determining the effectiveness of a rocket design, rocketeers speak in terms of mass fraction (MF). The mass of the propellants of the rocket divided by the total mass of the rocket gives mass fraction:

$$MF = \frac{\text{mass of propellants}}{\text{total mass}}$$

The mass fraction of the ideal rocket given above is 0.91. From the mass fraction formula one might think that an MF of 1.0 is perfect, but then the entire rocket would be nothing more than a lump of propellants that would simply ignite into a fireball. The larger the MF number, the less payload the rocket can carry; the smaller the MF number, the less its range becomes. An MF number of 0.91 is a good balance between payload-carrying capability and range. The Space Shuttle has an MF of approximately 0.82. The MF varies between the different orbiters in the Space Shuttle fleet and with the different payload weights of each mission.

Large rockets, able to carry a spacecraft into space, have serious weight problems. To reach space and proper orbital velocities, a great deal of propellant is needed; therefore, the tanks, engines, and associated hardware become larger. Up to a point, bigger rockets can carry more payload than smaller rockets, but when they become too large their structures weigh them down too much, and the mass fraction is reduced to an impossible number.

A solution to the problem of giant rockets weighing too much can be credited to the 16th-century fireworks maker Johann Schmidlap. Schmidlap attached small rockets to the top of big ones. When the large rocket was exhausted, the rocket casing was dropped behind and the remaining rocket fired. Much higher altitudes were achieved by this method. (The Space Shuttle follows the step rocket principle by dropping off its solid rocket boosters and external tank when they are exhausted of propellants.)

The rockets used by Schmidlap were called step rockets. Today this technique of building a rocket is called *staging*. Thanks to staging, it has become possible not only to reach outer space but the Moon and other planets too.

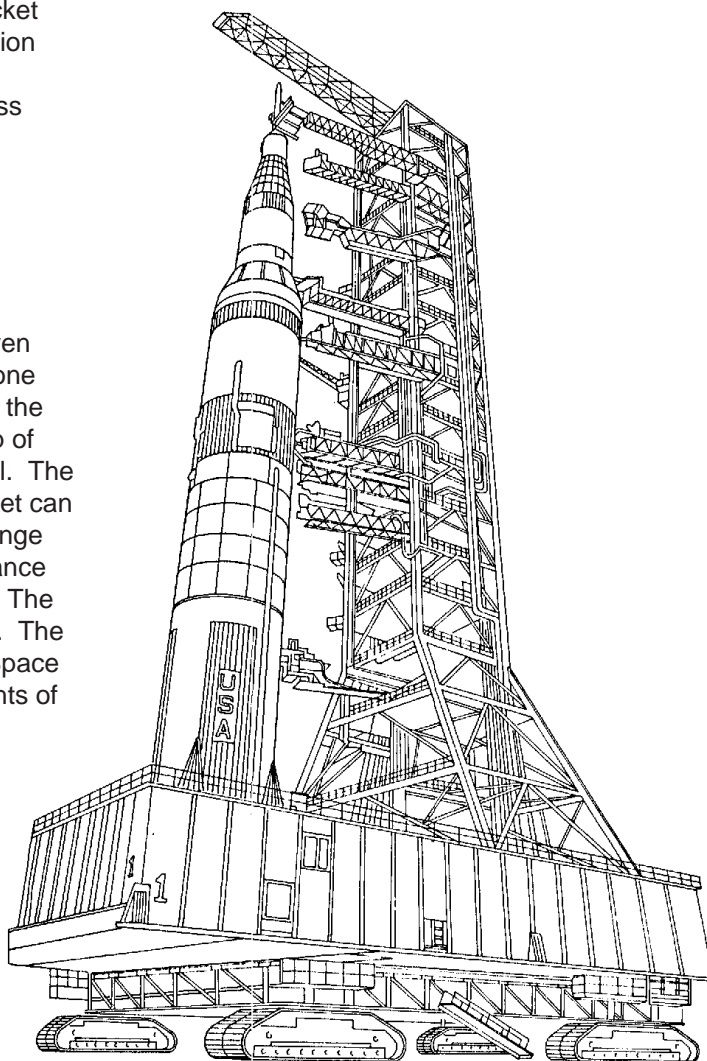

Saturn 5 rocket being transported to the launch pad.

# Rocket Stability Determination

A rocket that flies straight through the air is said to be a *stable* rocket. A rocket that veers off course or tumbles wildly is said to be an *unstable* rocket. The difference between the flight of a stable and unstable rocket depends upon its design. All rockets have two distinct "centers." The first is the *center of mass*. This is a point about which the rocket balances. If you could place a ruler edge under this point, the rocket would balance horizontally like a seesaw. What this means is that half of the mass of the rocket is on one side of the ruler edge and half is on the other. Center of mass is important to a rocket's design because if a rocket is unstable, the rocket will tumble about this center.

The other center in a rocket is the *center of pressure*. This is a point where half of the surface area of a rocket is on one side and half is on the other. The center of pressure differs from center of mass in that its location is not affected by the placement of payloads in the rocket. This is just a point based on the surface of the rocket, not what is inside. During flight, the pressure of air rushing past the rocket will balance half on one side of this point and half on the other. You can determine the center of pressure by cutting out an exact silhouette of the rocket from cardboard and balancing it on a ruler edge.

The positioning of the center of mass and the center of pressure on a rocket is critical to its stability. The center of mass should be towards the rocket's nose and the center of pressure should be towards the rocket's tail for the rocket to fly straight. That is because the lower end of the rocket (starting with the center of mass and going downward) has more surface area than the upper end (starting with the center of mass and going upward). When the rocket flies, more air pressure exists on the lower end of the rocket than on the upper end. Air pressure will keep the lower end down and the upper end up. If the center of mass and the center of pressure are in the same place, neither end of the rocket will point upward. The rocket will be unstable and tumble.

## Stability Determination Instructions

1. Tie a string loop around the middle of your rocket. Tie a second string to the first so that you can pick it up. Slide the string loop to a position where the rocket balances. You may have to temporarily tape the nose cone in place to keep it from falling off.
2. Draw a straight line across the scale diagram of the rocket you made earlier to show where the ruler's position is. Mark the middle of the line with a dot. This is the rocket's center of mass.
3. Lay your rocket on a piece of cardboard. Carefully trace the rocket on the cardboard and cut it out.

4. Lay the cardboard silhouette you just cut out on the ruler and balance it.
5. Draw a straight line across the diagram of your rocket where the ruler is. Mark the middle of this line with a dot. This is the center of pressure of the rocket.

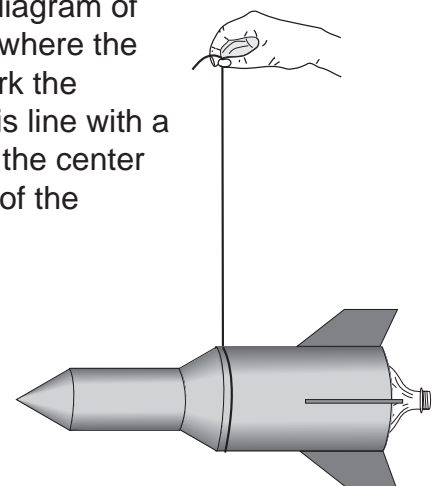



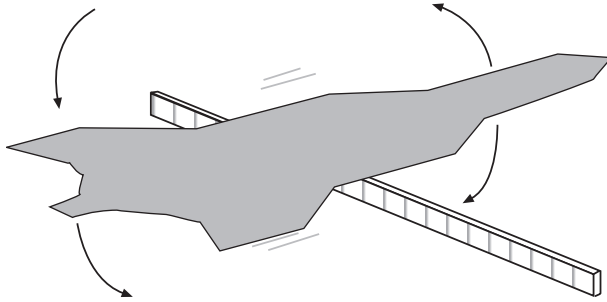

If your center of mass is in front of the center of pressure, your rocket should be stable. Proceed to the swing test. If the two centers are next to or on top of each other, add more clay to the nosecone of the rocket. This will move the center of mass forward. Repeat steps 2 and 3 and then proceed to the swing test.

**Swing Test:**

1. Tape the string loop you tied around your rocket in the previous set of instructions so that it does not slip.
2. While standing in an open place, slowly begin swinging your rocket in a circle. If the rocket points in the direction you are swinging it, the rocket is stable. If not, add more clay to the rocket nose cone or replace the rocket fins with larger ones. Repeat the stability determination instructions and then repeat the swing test.

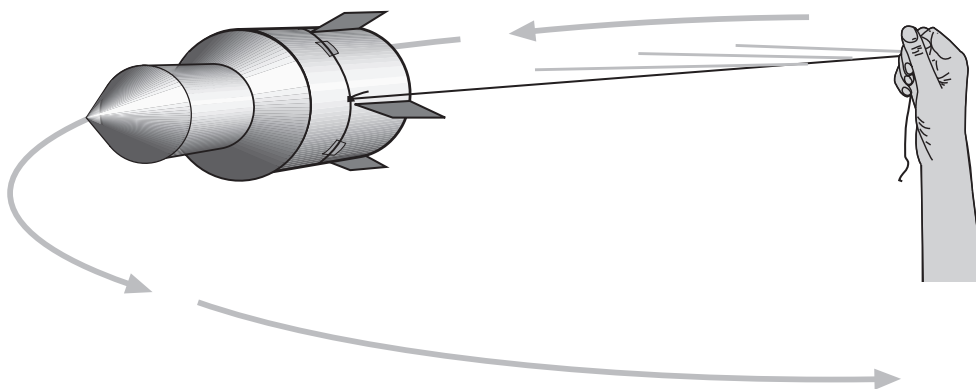
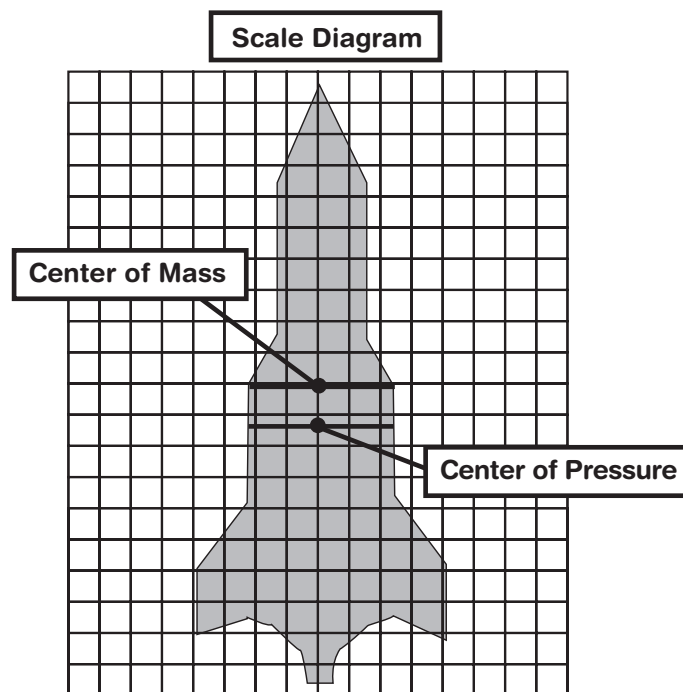

# Launch Vehicle Family Album

The pictures on the next several pages serve as a partial "family album" of NASA launch vehicles. NASA did not develop all of the vehicles shown, but has employed each in its goal of "exploring the atmosphere and space for peaceful purposes for the benefit of all." The album contains historic rockets, those in use today, and concept designs that might be used in the future. They are arranged in three groups: rockets for launching satellites and space probes, rockets for launching humans into space, and concepts for future vehicles.

The album tells the story of nearly 40 years of NASA space transportation. Rockets have probed the upper reaches of Earth's atmosphere, carried spacecraft into Earth orbit, and sent spacecraft out into the solar system and beyond. Initial rockets employed by NASA, such as the Redstone and the Atlas, began life as intercontinental ballistic missiles. NASA scientists and engineers found them ideal for carrying machine and human payloads into space. As the need for greater payload capacity increased, NASA began altering designs for its own rockets and building upper stages to use with existing rockets. Sending astronauts to the Moon required a bigger rocket than the rocket needed for carrying a small satellite to Earth orbit.

Today, NASA's only vehicle for lifting astronauts into space is the Space Shuttle. Designed to be reusable, its solid rocket boosters have parachute recovery systems. The orbiter is a winged spacecraft that glides back to Earth. The external tank is the only part of the vehicle which has to be replaced for each mission.

Launch vehicles for the future will continue to build on the experiences of the past. Vehicles will become more versatile and less expensive to operate as new technologies become available.



# Rocket Timeline

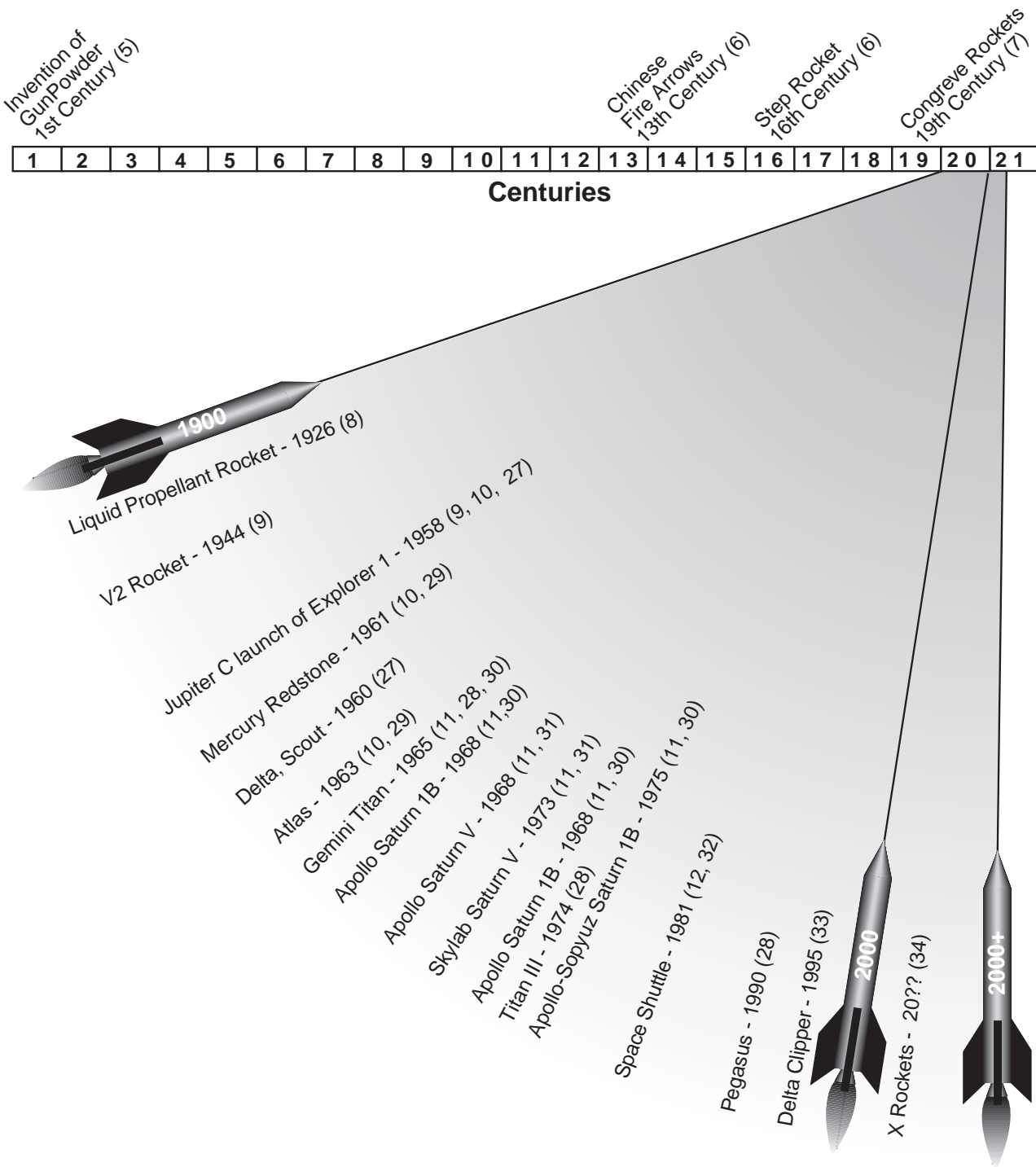

Most significant rocket developments have taken place in the twentieth century. After 1958, all entries in this timeline relate to NASA space missions. Provided here are the years in which new rocket systems were first flown. Additional information about these events can be found in this guide on the pages indicated by parentheses.



## Rockets for Launching Satellites and Space Probes

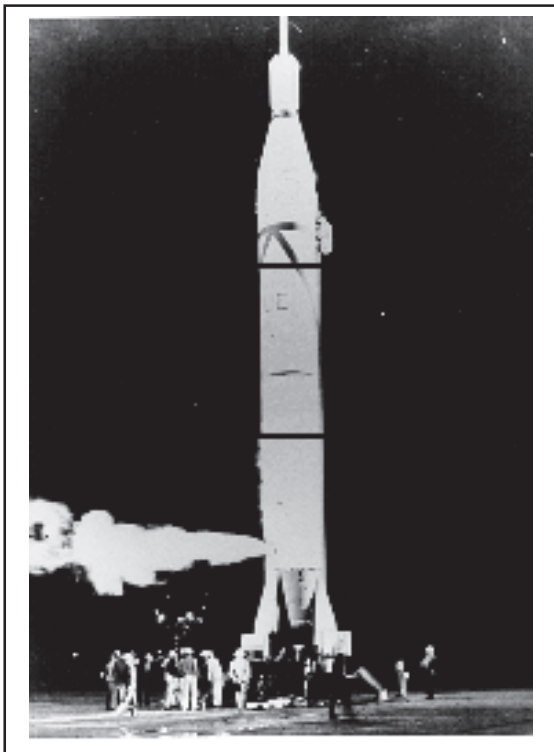

Engineers prepare the Jupiter-C rocket that carried *Explorer 1* into space on January 31, 1958.



NASA's Scout rocket is a four-stage solid rocket booster that can launch small satellites into Earth orbit. The Scout can carry about a 140 kilogram payload to a 185 kilometer high orbit. NASA used the Scout for more than 30 years. This 1965 launch carried the *Explorer 27* scientific satellite.



One of NASA's most successful rockets is the Delta. The Delta can be configured in a variety of ways to change its performance to meet needs of the mission. It is capable of carrying over 5,000 kilograms to a 185 kilometer high orbit or 1,180 kilograms to a geosynchronous orbit with an attached booster stage. This Delta lifted the *Galaxy-C* communication satellite to space on September 21, 1984.





A Titan III Centaur rocket carried *Voyager 1*, the first interplanetary spacecraft to fly by both Jupiter and Saturn, into space on September 5, 1975. The Titan, a U.S. Air Force missile, combined with NASA's Centaur upper stage and two additional side-mounted boosters, provided the needed thrust to launch *Voyager*.

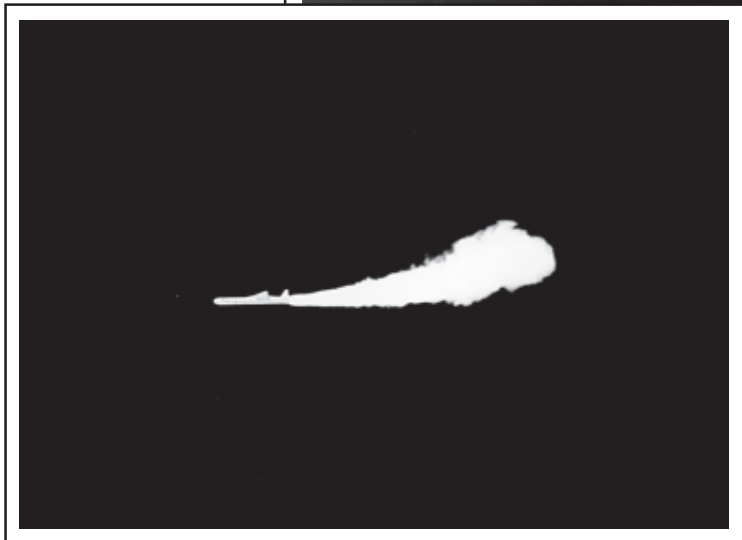
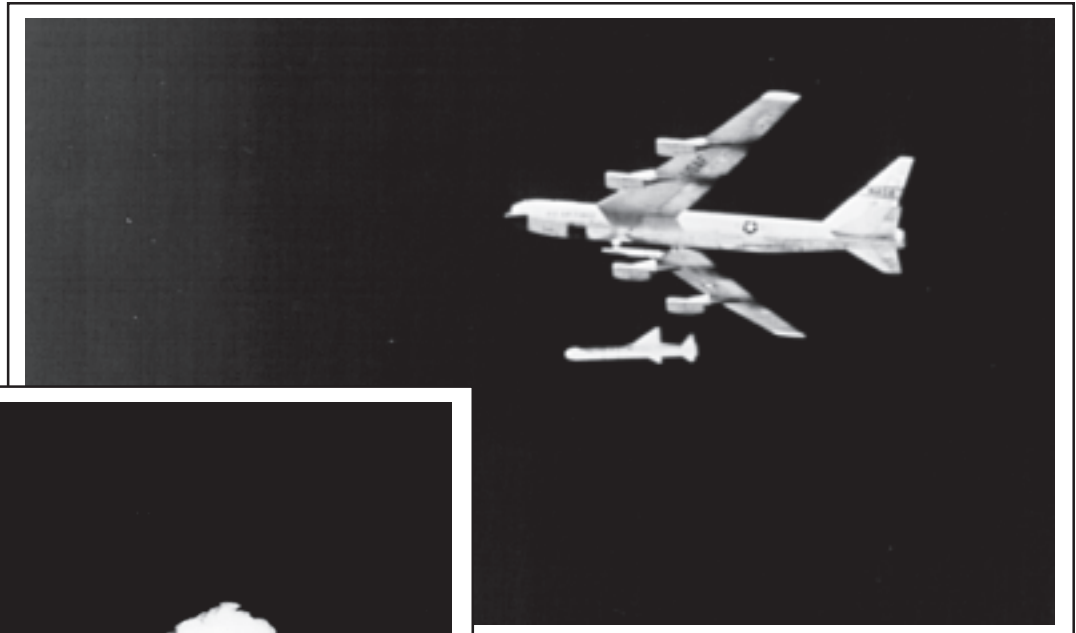

The Pegasus air-launched space booster roars toward orbit following its release from a NASA *B-52* aircraft. The booster, built by Orbital Sciences Corporation and Hercules Aerospace Company, is a low-cost way of carrying small satellites to Earth orbit. This launch took place on April 5, 1990.



## Rockets for Sending Astronauts Into Space

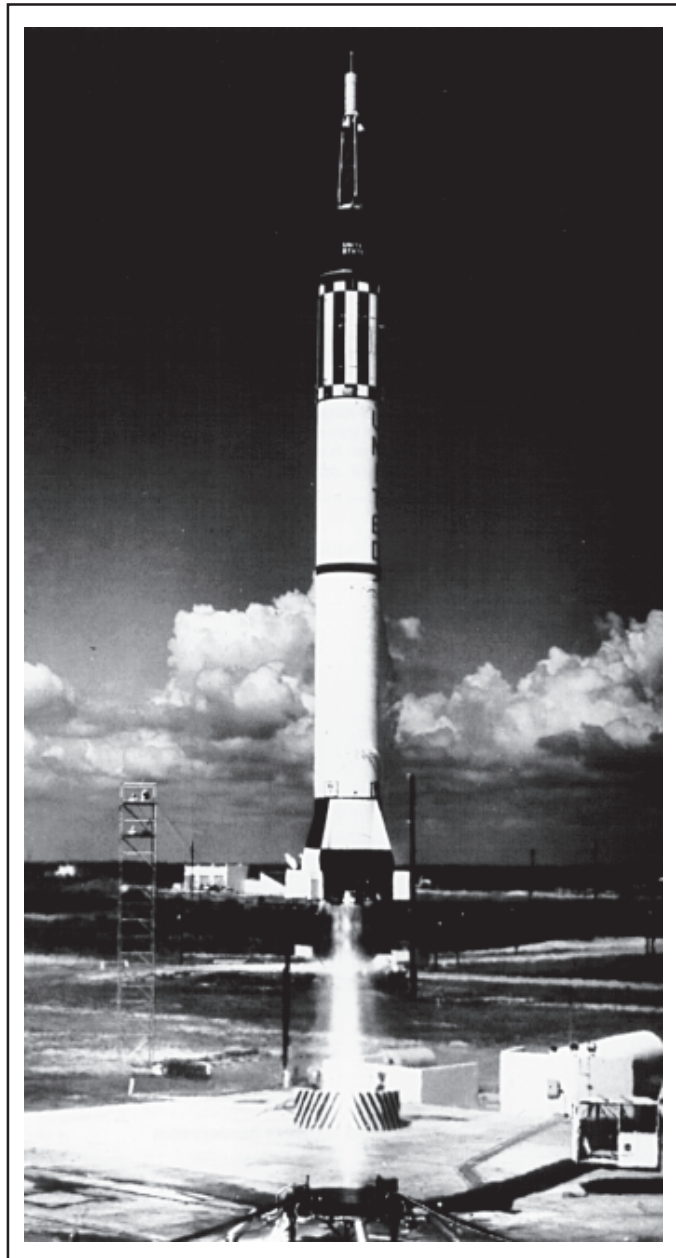

Allan Shepard became the first American astronaut to ride to space on May 5, 1961. Shepard rode inside a *Mercury* space capsule on top of a Redstone rocket.



An Atlas launch vehicle, with a *Mercury* space capsule at the top, underwent a static firing test to verify engine systems before its actual launch. The *Mercury/Atlas* combination launched four *Mercury* orbital missions including the historic first American orbital flight of John Glenn.





Virgil I. Grissom and John W. Young rode to orbit inside a *Gemini* spacecraft mounted at the top of this Titan rocket. The spacecraft reached an orbit ranging from 161 to 225 kilometers on March 23, 1965.



Used to lift *Apollo* spacecraft to Earth orbit, the nearly 70-meter-tall Saturn 1B rocket carries the *Apollo 7* crew on October 11, 1968. Saturn 1B rockets also transported crews for *Skylab* (1973-74) and *Apollo/Soyuz* missions (1975).

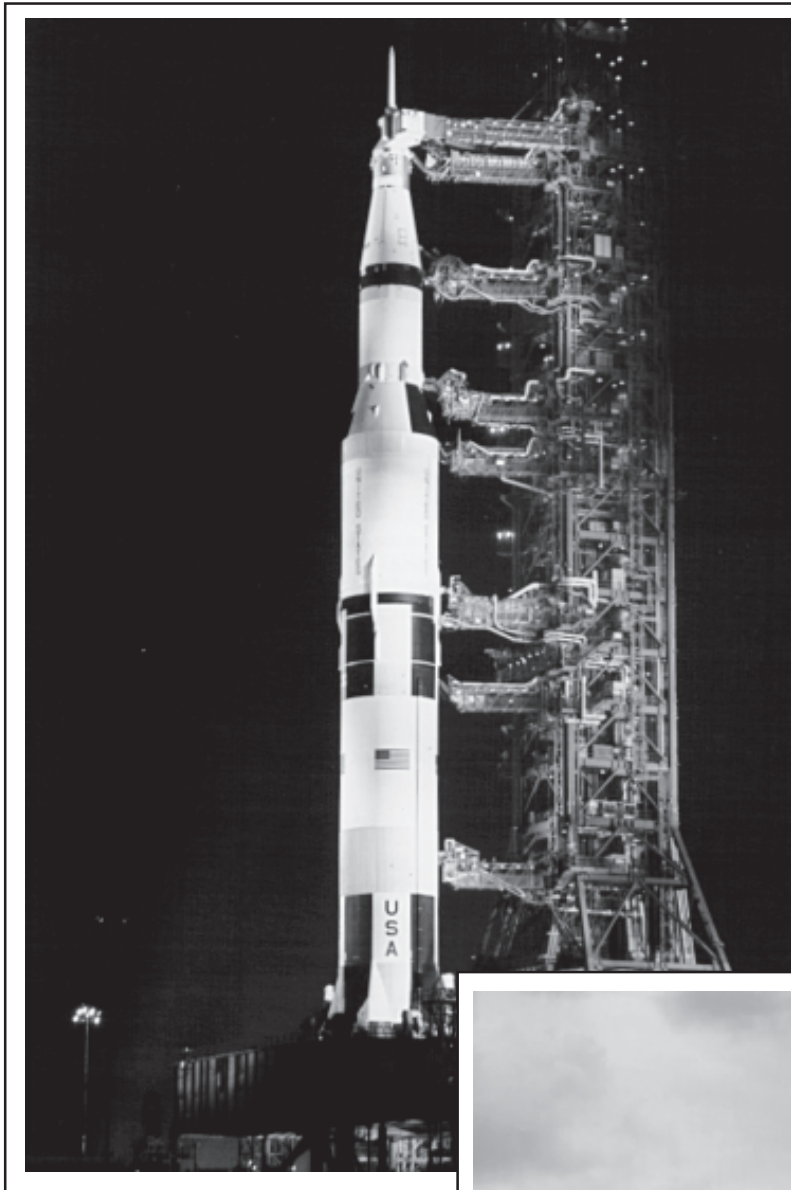

The 111-meter-high Saturn 5 rocket carried the *Apollo 11* crew to the Moon.

Using a modified Saturn 5 rocket, NASA sent the 90,600 kilogram *Skylab* Space Station to orbit on May 14, 1973. The space station replaced the Saturn 5's third stage.







Today, NASA Astronauts launch into space onboard the Space Shuttle. The Shuttle consists of a winged orbiter that climbs into space as a rocket, orbits Earth as a satellite, and lands on a runway as an airplane. Two recoverable solid rocket boosters provide additional thrust and an expendable external tank carries the propellants for the orbiter's main engines. This was the launch of STS-53 on December 2, 1992.



## Concepts for Future Vehicles

The launch vehicles on this and the next page are ideas for future reusable launch vehicles. Most are variations of the winged Space Shuttle orbiter.



The Delta Clipper Experimental (DC-X) vehicle, originally developed for the Department of Defense, lifts off at the White Sands Missile Range in New Mexico. NASA has assumed the role of managing the vehicle's further development. The DC-X lifts off and lands vertically. NASA hopes this vehicle could lead to a low-cost payload launching system. The Delta Clipper was recently renamed the "Clipper Graham" in honor of the late space pioneer Lt. General Daniel O. Graham.



The X-34 is a reusable booster concept that could lead to larger vehicles in the future. This rocket would launch from a carrier aircraft to deliver a payload to orbit.



NASA has chosen this concept to replace the Space Shuttle fleet in the 21st century. The X-33 will be a single-stage-to-orbit vehicle in which the entire vehicle lifts off into space and returns to Earth intact.



Looking like a Space Shuttle orbiter, this new launcher concept is also a single-stage-to-orbit vehicle.



# Glossary

**Action** - A force (push or pull) acting on an object. See Reaction.

**Active Controls** - Devices on a rocket that move to control the rocket's direction in flight.

**Attitude Control Rockets** - Small rockets that are used as active controls to change the attitude (direction) a rocket or spacecraft is facing in outer space.

**Canards** - Small movable fins located towards the nose cone of a rocket.

**Case** - The body of a solid propellant rocket that holds the propellant.

**Center of Mass (CM)** - The point in an object about which the object's mass is centered.

**Center of Pressure (CP)** - The point in an object about which the object's surface area is centered.

**Chamber** - A cavity inside a rocket where propellants burn.

**Combustion Chamber** - See Chamber.

**Drag** - Friction forces in the atmosphere that "drag" on a rocket to slow its flight.

**Escape Velocity** - The velocity an object must reach to escape the pull of Earth's gravity.

**Extravehicular Activity (EVA)** - Spacewalking.

**Fins** - Arrow-like wings at the lower end of a rocket that stabilize the rocket in flight.

**Fuel** - The chemical that combines with an oxidizer to burn and produce thrust.

**Gimbaled Nozzles** - Tiltable rocket nozzles used for active controls.

**Igniter** - A device that ignites a rocket's engine(s).

**Injectors** - Showerhead-like devices that spray fuel and oxidizer into the combustion chamber of a liquid propellant rocket.

**Insulation** - A coating that protects the case and nozzle of a rocket from intense heat.

**Liquid Propellant** - Rocket propellants in liquid form.

**Mass** - The amount of matter contained within an object.

**Mass Fraction (MF)** - The mass of propellants in a rocket divided by the rocket's total mass.

**Microgravity** - An environment that imparts to an object a net acceleration that is small compared with that produced by Earth at its surface.

**Motion** - Movement of an object in relation to its surroundings.

**Movable Fins** - Rocket fins that can move to stabilize a rocket's flight.

**Nose Cone** - The cone-shaped front end of a rocket.

**Nozzle** - A bell-shaped opening at the lower end of a rocket through which a stream of hot gases is directed.

**Oxidizer** - A chemical containing oxygen compounds that permits rocket fuel to burn both in the atmosphere and in the vacuum of space.

**Passive Controls** - Stationary devices, such as fixed rocket fins, that stabilize a rocket in flight.

**Payload** - The cargo (scientific instruments, satellites, spacecraft, etc.) carried by a rocket.

**Propellant** - A mixture of fuel and oxidizer that burns to produce rocket thrust.

**Pumps** - Machinery that moves liquid fuel and oxidizer to the combustion chamber of a rocket.

**Reaction** - A movement in the opposite direction from the imposition of an action. See Action.

**Rest** - The absence of movement of an object in relation to its surroundings.

**Regenerative Cooling** - Using the low temperature of a liquid fuel to cool a rocket nozzle.

**Solid Propellant** - Rocket fuel and oxidizer in solid form.

**Stages** - Two or more rockets stacked on top of each other in order to reach higher altitudes or have a greater payload capacity.

**Throat** - The narrow opening of a rocket nozzle.

**Unbalanced Force** - A force that is not countered by another force in the opposite direction.

**Vernier Rockets** - Small rockets that use their thrust to help direct a larger rocket in flight.



# NASA Educational Materials

NASA publishes a variety of educational resources suitable for classroom use. The following resources, specifically relating to the topic of rocketry, are available from the NASA Teacher Resource Center Network. Refer to the next pages for details on how to obtain these materials.

## Liftoff to Learning Educational Video Series That Relate to Rockets

### **Space Basics**

Length: 20:55

Recommended Level: Middle School

Application: History, Physical Science

*Space Basics* explains space flight concepts such as how we get into orbit and why we float when orbiting Earth. Includes a video resource guide.

### **Newton in Space**

Length: 12:37

Recommended Level: Middle School

Application: Physical Science

*Newton in Space* demonstrates the difference between weight and mass and illustrates Isaac Newton's three laws of motion in the microgravity environment of Earth Orbit. Includes a video resource guide.

## Other Videos

Videotapes are available about Mercury, Gemini, Apollo, and Space Shuttle projects and missions. Contact the Teacher Resource Center that serves your region for a list of available titles, or contact CORE (See page 109.).

## Publications

- McAleer, N. (1988), Space Shuttle - The Renewed Promise, National Aeronautics and Space Administration, PAM-521, Washington, DC.
- NASA (1991), Countdown! NASA Launch Vehicles and Facilities, Information Summaries, National Aeronautics and Space Administration, PMS-018-B, Kennedy Space Center, FL.
- NASA (1991), A Decade On Board America's Space Shuttle, National Aeronautics and Space Administration, NP-150, Washington, DC.
- NASA (1987), The Early Years: Mercury to Apollo-Soyuz, Information Summaries, National Aeronautics and Space Administration, PMS-001-A, Kennedy Space Center, FL.
- NASA (1991), Space Flight, The First 30 Years, National Aeronautics and Space Administration, NP-142, Washington, DC.
- NASA (1992), Space Shuttle Mission Summary, The First Decade: 1981-1990, Information Summaries,

- National Aeronautics and Space Administration, PMS-038, Kennedy Space Center, FL.
- Roland, A. (1985), A Spacefaring People: Perspectives on Early Spaceflight, NASA Scientific and Technical Information Branch, NASA SP-4405, Washington, DC.

## Lithographs

- HqL-367 Space Shuttle *Columbia* Returns from Space.
- HqL-368 Space Shuttle *Columbia* Lifts Off Into Space.

## Suggested Reading

These books can be used by children and adults to learn more about rockets. Older books on the list provide valuable historical information rockets and information about rockets in science fiction. Newer books provide up-to-date information about rockets currently in use or being planned.

- Asimov, I. (1988), Rockets, Probes, and Satellites, Gareth Stevens, Milwaukee.
- Barrett, N. (1990), The Picture World of Rockets and Satellites, Franklin Watts Inc., New York.
- Bolognese, D. (1982), Drawing Spaceships and Other Spacecraft, Franklin Watts, Inc., New York.
- Branley, F. (1987), Rockets and Satellites, Thomas Y. Crowell, New York.
- Butterfield, M. (1994), Look Inside Cross-Sections Space, Dorling Kindersley, London.
- Donnelly, J. (1989), Moonwalk, The First Trip to the Moon, Random House, New York.
- English, J. (1995), Transportation, Automobiles to Zeppelins, A Scholastic Kid's Encyclopedia, Scholastic Inc., New York.
- Fischel, E. & Ganeri, A. (1988), How To Draw Spacecraft, EDC Publishing, Tulsa, Oklahoma.
- Furniss, T. (1988), Space Rocket, Gloucester, New York.
- Gatland, K. (1976), Rockets and Space Travel, Silver Burdett, Morristown, New Jersey.
- Gatland, K. & Jeffris, D. (1977), Star Travel: Transport and Technology Into The 21st Century, Usborn Publishers, London.
- Gurney, G. & Gurney, C. (1975), The Launch of Sputnik, October 4, 1957: The Space Age Begins, Franklin Watts, Inc., New York.
- Malone, R. (1977), Rocketship: An Incredible Voyage Through Science Fiction and Science Fact, Harper & Row, New York.
- Maurer, R. (1995), Rocket! How a Toy Launched the Space Age, Crown Publishers, Inc., New York.
- Mullane, R. M. (1995), Liftoff, An Astronaut's Dream, Silver Burdett Press, Parsippany, NJ.



- Neal, V., Lewis, C., & Winter, F. (1995), Smithsonian Guides, Spaceflight, Macmillan, New York. (Adult level reference)
- Parsons, A. (1992), What's Inside? Spacecraft, Dorling Kindersley, Inc., New York.
- Ordway, F. & Leibermann, R. (1992), Blueprint For Space, Science Fiction To Science Fact, Smithsonian Institution Press, Washington DC.
- Quackenbush, R. (1978), The Boy Who Dreamed of Rockets: How Robert Goddard Became The Father of the Space Age, Parents Magazine Press, New York.
- Ride, S. & Okie, S. (1986), To Space & Back, Lee & Shepard Books, New York.
- Shayler, D. (1994), Inside/Outside Space, Random House, New York.
- Shorto, R. (1992), How To Fly The Space Shuttle, John Muir Publications, Santa Fe, NM.
- Vogt, G. (1987), An Album of Modern Spaceships, Franklin Watts, Inc., New York.
- Vogt, G. (1989), Space Ships, Franklin Watts, Inc., New York.
- Winter, F. (1990), Rockets into Space, Harvard University Press, Cambridge, Massachusetts. (Adult level reference)

## Commercial Software

Physics of Model Rocketry  
Flight: Aerodynamics of Model Rockets  
In Search of Space - Introduction to Model Rocketry  
 The above programs are available for Apple II, Mac, and IBM from Estes Industries, 1295 H. Street, Penrose, Colorado 81240

## Electronic Resources

The following listing of Internet addresses will provide users with links to educational materials throughout the World Wide Web (WWW) related to rocketry.

### NASA Resources

NASA SpaceLink  
<http://spacelink.msfc.nasa.gov>

NASA Home Page  
<http://www.nasa.gov/>

Space Shuttle Information  
<http://shuttle.nasa.gov/index-n.html>

